

D1.9

Start-up and intermediate results of plant operation from all case studies

Disclaimer: This deliverable has not yet been approved by the European Commission and should be seen as draft!

Author(s): A. Naves Arnaldos, J. van den Broeke, T. Guleria, C. Bruni, F. Fantone, M. Touloupi, D. Iossifidis, A. Giménez Lorang, I. Sabbah, K. Farah, K. Baransi-Karkaby, M. Pidou, A. Reguer, A. Kleyböcker, J. Jährig, L. Vredenburg, P. Thisgaard.

Date: 31/01/2023





Technical References

Project Acronym	ULTIMATE
Project Title	ULTIMATE: indUstry water-utiLiTy symbiosis for a sMarter wATer society
Project Coordinator	Gerard van den Berg KWR
Project Duration	01.06.2020 – 31.05.2024 (48 months)

Deliverable No.	1.9
Dissemination level ¹	PU
Work Package	1
Task	
Lead beneficiary	EUT
Contributing beneficiary(ies)	UNIVPM, KWR, GTG TECH, AQUALIA, GSR, UCRAN, SUEZ RR, X-FLOW, KALUND, KWB
Author(s)	A. Naves Arnaldos, J. van den Broeke, T. Guleria, C. Bruni, F. Fantone, M. Touloupi, D. Iossifidis, A. Giménez Lorang, I. Sabbah, K. Farah, K. Baransi-Karkaby, M. Pidou, A. Reguer, A. Kleyböcker, J. Jährig, L. Vredenburg, P. Thisgaard.
Quality Assurance	Sandra Casas
Due date of deliverable	31-1-2023
Actual submission date	31-1-2023

¹ PU = Public

PP = Restricted to other programme participants (including the Commission Services)

RE = Restricted to a group specified by the consortium (including the Commission Services)

CO = Confidential, only for members of the consortium (including the Commission Services)





Document history

V	Date	Author(s) /Reviewer(s) (Beneficiary)	Description
0.1	19.1.2023	Sandra Casas (EUT)	First internal review
0.2	20.1.2023	A. Naves, J. van den Broeke, T. Guleria, C. Bruni, F. Fantone, M. Touloupi, D. Iossifidis, A. Giménez Lorang, I. Sabbah, K. Farah, K. Baransi-Karkaby, M. Pidou, A. Reguer, A. Kleyböcker, J. Jährig, L. Vredembregt, P. Thisgaard.	CS chapters revision
0.3	23.1.2023	Christian Remy (KWB)	External review
0.4			
1			

INSTRUCTION (this box is to be deleted in the final version)

Every deliverable needs to have undergone quality assurance with regards to content (reviewer to be selected by WP leader) and the ULTIMATE quality officer (Sandra Casas, Eurecet).

Both QA processes should be documented in the 'Document History' table above.





Executive Summary

Summary of Deliverable

ULTIMATE promotes circular economy solutions that are in line with the ambitions of the European Green Deal (European Commission 2019) its Action Plan for Circular Economy (European Commission 2020) to reduce strongly our greenhouse gas emissions, to provide clean water, to maintain healthy soil, make industry resilient and produce cleaner energy.

ULTIMATE aims to establish and foster water smart industrial symbioses by implementing circular economy solutions for water, material and energy recovery. The circular economy solutions shall create a win-win situation for both the water sector and the industry. In nine case studies the water sector forms those symbioses with companies from the agro-food, beverage, petrochemical, chemical and biotech industry.

Objective of the deliverable and links to other deliverables

This deliverable includes a detailed description of the final design and realization of all pilot plants in ULTIMATE, together with the results from the commissioning, start-up phase as well as intermediate results of normal plant operation. It will report on the status of pilot activities, identify challenges and how they have been addressed by the consortium.

This report will provide valuable feedback on the pilot system design and start-up for similar activities in the future. Based on the intermediate results, the planned research activities in WP1 until the end of the project will be adapted, if necessary. D1.9 is linked to the subtasks dealing with investigations in pilot plants such as 1.2.1, 1.2.2, 1.2.4-1.2.9, 1.3.1-1.3.5, 1.4.1-1.4.3, 1.4.5-1.4.7.

This deliverable serves as an intermediate evaluation of the pilot plant activities and has a preparative function for the successful achievement of D1.3, D1.4 and D1.5. This document collects the information about the pilot plant start-up operation and results until November 2022.

Finally, this deliverable (D1.9) presents technologies that can be applied in the frame of the Regulation (EU) 2020/741 on minimum requirements for water reuse, the Regulation (EU) 2019/1009 laying down rules on the making available on the market of EU fertilising products and the Directive (EU) 2018/2001 on the promotion of the use of energy from renewable sources.

Results

Each case study is focused on closing the loops of water, energy and material/nutrients recovery. Depending on the topics each case study is involved in, pilot plants with different technologies have been designed and built to conduct trials in the industrial partners facilities.

In this deliverable includes an update (November 2022) of the status of the pilot plant for each case study, together with details from the commissioning, start-up operation and preliminary results of the operation.





Through to the experimental work carried out so far in the different case studies, both at laboratory and pilot plant scale, general conclusions and several common lessons learned can be drawn:

1. **Preliminary work.** The design and construction of the pilot plant has required, for some case studies, preliminary work characterizing wastewater or by-products as starting point.

On the other hand, initial technology assessment at laboratory scale can provide very helpful information to scale up it at pilot plant scale. In several case studies, initial trials at laboratory scale were conducted to determine optimal operation conditions. In some cases, the experiments initially were performed with synthetic water and subsequently repeated with real water to obtain more realistic results. This information was used subsequently for the pilot plant design.

2. **Challenges of pilot plant design and construction.** In this phase, most of the case studies have had to transfer the technical requirements and specifications of the pilot plants to external companies, usually engineering or technology providers for the pilot plant design and construction. Sometimes, technical requirements are not standard, and providers have to understand and adapt their technologies and processes to the needs of the research tasks.

On the other hand, in some case studies, the pilot plant has been designed and built by two or more suppliers, which can hinder the coordination tasks necessary for the complete construction of the pilot plant. Furthermore, in some cases, a multi-sectorial expertise team has been built in order to get a comprehensive industrial design.

Finally, some case studies had to face up more challenges by designing and building two or more pilot plants to evaluate all the technologies required to recover water, energy and/or materials. Design two or more pilot plants normally translate not only into more workload but higher risks about delays and difficulties to manage logistics and start-up operation.

In most of the case studies there were substantial delays with the construction for different reasons, some of them external to the case studies management: Covid-19 restrictions and subsequent delays with delivery of components (i.e. electrical and electronic material and devices supply).

3. **Experience from pilot plant commissioning and start-up.** Once the pilot plant is installed at the industrial partner facilities, start-up operation can begin. Main difficulties faced during the start-up and operation of the pilot plants were the malfunctioning of some equipment and instrumentation, that sometimes, required the adaptation or redesign of some part of the pilot plant.

Other kind of problems that appeared in the start-up and first days of pilot plants operation were related to water leaks and electrical safety aspects.

4. **Pilot plants status.** Most of the case studies have their pilot plants in operation at the deliverable submission date, but not all the case studies can present preliminary plant operation results due to delays in pilot plant construction and





commissioning or problems during the start-up operation. Instead, laboratory scale results are presented and discussed.

- In **Case Study 1 (Tarragona, Spain)**, a 12 m³/day pilot plant is currently in operation, including the following technologies: ultrafiltration, reverse osmosis, membrane distillation and adsorption on zeolites. For the design and construction of the pilot plant, two different suppliers were needed, and this, translated in extra difficulties in coordinating the assembly, logistics and start-up operation. Pilot plant commissioning was done in November 2022, and for this reason, preliminary results are not available to be included in this deliverable. Instead of this, laboratory results for the four technologies are included in this report.
- **Case Study 2 (Nieuw Prinseland, Netherlands)** the pilot plant for water and nutrient recovery was realised. The solution uses capacitive electro dialysis as a means of separation and can treat 0.1m³/day. The system has been commissioned and calibrated in the laboratory by performing control experiments and is ready to be moved to the case study site. No major problems were encountered during commissioning and start-up, but updates of the potentiostat that generates the voltages over the membranes, was required to provide a higher capacity. Also, small redesign of the membrane stack was required, as the used material has proven to be too fragile, leading to crack and leakage.
- In **Case Study 3 (Rosignano, Italy)** the adsorption pilot-system, put in operation in July 2022, has been realized with the scope to test alternative adsorbent materials to replace GAC during wastewater treatment, and to investigate the use of innovative sensors based on fluorescence and UV absorbance spectroscopy (UV₂₅₄ sensor) for process control and monitoring the breakthrough curves of organic material and organic macropollutants.
- In **Case Study 4 (Nafplio, Greece)** the pilot plant has been already fully deployed at the quarters of Alberta S.A. It has the capacity to treat 10m³/day of water by product originating from various juice production streams. The pilot comprises all the processes needed to recover valued-added compounds, polyphenols, with an adsorption/extraction unit, and wastewater treatment: coagulation and advance oxidation process to remove organic load. The pilot unit is currently operational, though we are still facing teething issues mainly piping leaking and automation issues. We are currently working to integrate more features of the pilot unit under the automation platform. Although pilot plant is in operation, in this report laboratory experiments results are presented.
- In **Case Study 5 (Lleida, Spain)** a 2 m³/h NF pilot plant is in operation to treat wastewater from the brewery. In Case Study 5 (Lleida, Spain), nanofiltration and reverse osmosis pilot plant, with a treatment capacity of 2 m³/h, has been tested for 7 months (between January and September 2022). The obtained NF and RO treated wastewater met, without exception, all the legal requirements for water reuse. The tested technology showed to be robust, tolerating well the oscillations of the water and presenting a stable process in terms of membrane fouling. The pilot test allowed to define the optimal operation settings regarding the NF technology.





Regarding ELSAR®, a pre-commercial industrial-size plant with capacity of treating 20 m³/h of brewery wastewater or an equivalent of 2000 kg COD/day will be built in 2023. The expected biogas production will be 31 Nm³/h. Due to the delays in the pre-commercial ELSAR®, a pilot ELSAR® has been installed. It will treat real brewery wastewater, aiming the validation of processes and structures. The pilot plant contains all the needed elements for simulate in a pilot-scale the same process than in the big-scale, although some processes (like biogas treatment) are inexistent. It is expected to be run beginning 2023 and a capacity of ca. 5 m³/h.

After installation during all 2022, the AnMBR pilot plant will be commissioned (by means of using anaerobic inoculum) in December 2022, with a capacity of treating ca. 2 m³/h or around 50 m³/d, and a biogas production of ca. 3,5 m³/h.

After installation in spring 2022, the safety inspections in summer 2022, and the commissioning in autumn 2022, the solid oxide fuel cell pilot plant will be commissioned in December 2022, with a capacity of producing 1.3 kW_{electric} and an approx. consumption of 10 m³ of biogas/ day. It will be fed with pre-treated biogas.

Thermosolar-based device has been tested in the batch tests, after 7 hours in a sunny day with normal sunlight irradiation (700-900 W/m²), the tested technology increased between 0,5 and 10-fold the dry matter of the tested samples, depending on the type of sludge (dewatered, thickened or composted). Temperature could not be increased in the HydroThermal Carbonization ranges (>180°C), which forces further research for optimize solar heat profit. Through the tested thermal treatment, Salmonella sp. was easily inactivated, but *Escherichia Coli* and especially *Clostridium perfringens* were not always inactivated even after 30 minutes of treatment. Again, a better heat distribution may help to obtain better results.

- **In Case Study 6 (Karmiel and Shafdan, Israel)** there are two pilot plants in operation. In Karmiel, currently, the advanced anaerobic technology pilot receives 120 m³/d of wastewater with a COD, TS and TVS loads of 238 kg/day, 97 kg/d and 88 kg/day, respectively. The biogas production rate is 0.3 Nm³/h with a methane content of 70% on average. 98.4–99.6% of the municipal wastewater is mixed with 0.4 – 1.6% olive mill wastewater and treated anaerobically by the advanced anaerobic pilot plant to produce biogas. On the other hand, tests with Karmiel pilot plant will be conducted after integrating the polyphenol extraction unit (adsorption column) from Greener than Greener (CS4), which arrived end of November 2022. It is expected to complete its instillation and start-up in January 2022.

To improve the biogas production and the effluent water quality, an immobilized biofilm **advanced anaerobic technology** is combined with membrane filtration and activated carbon at the pilot-scale in Shafdan. The pilot at the Shafdan has been installed, and its operation was started in August 2022. This demonstration system represents a very large WWTP, in order to provide insight into the capability of large WWTPs to combine agro-industrial wastewater. The demonstration plant at the Shafdan receives 12-





24 m³/day of municipal wastewater with a COD load of 0.5 m³/d. That volume (12-24 m³/d) will be mixed with 0.2-2 m³/d of oily mill wastewater and will be further treated by AAT and AnMBR systems to produce biogas. Although pilot plant is in operation, and several tests have been conducted with the AAT system and membrane, some problems about sensors, electrical panel and control system took place and for this reason, the complete start-up operation is not already completed.

- In **Case Study 7 (Tain, United Kingdom)** there are two different pilot plants. There is in operation a 1 m³/h pilot plant to recover nutrients from distillery effluent (nitrogen, 800 mg/L and phosphorus 250 mg/L). The pilot plant has first precipitation process for the formation of struvite in a 5 m tall reactor followed by a clarifier and under controlled conditions. As the ammonia is in excess, this step will be focused on maximising the removal of the phosphorus with a target of 80%. The effluent will be further treated in a 5 m tall stripping unit for the removal and recovery of the remaining ammonia present with an overall ammonia recovery target of 90%. In this case, the ammonia will be recovered in the form of an ammonium sulphate solution by scrubbing with sulfuric acid. Both units are designed to treat a flow of 1 m³/h.

For water reuse, a reverse osmosis pilot unit will be used, although currently is installed, commissioned but not in operation. The system is designed to treat flows of up to 1 m³/day and is semi-automated. The unit comprises a feed tank fitted with a heating system to control the temperature of the feed water. This will be of particular interest for the evaluation of residual heat utilisation, to understand the impact of temperature on the treatment and operational performance of the reverse osmosis membranes.

- In **Case Study 8 (Roussillon, France)**, a 500 Nm³/h absorption pilot plant is designed but not built and it is expected to be implemented in April 2023. Initial laboratory tests were conducted, using synthetic gases, to assess the influence of several parameters on sulphur dioxide absorption. Absorption efficiencies > 95% were obtained, considering that pH 6-9.5 and low temperature promote sulphur dioxide absorption. Furthermore, initial concentration in adsorption solution and sulphur dioxide concentration in the inlet gas seemed not to be impact on sulphur dioxide absorption efficiency,
- In **Case Study 9 (Kalundborg, Denmark)** two parallel operated membrane pilot plants are operated to produce fit-for-purpose water for cooling purposes or for stream production. Their point of application is in the secondary effluent of a municipal wastewater treatment plant, which treats municipal wastewater and pre-treated pharmaceutical and biotech wastewater. The composition of the secondary effluent contains a high fraction of non-degradable organic compounds and is quite challenging for the pilot plants. Until now, different configurations were tested such as the combination of a conventional UF with a RO, an ultra-tight UF with a RO and an open NF with a RO.

The treatment via UF and open NF membranes alone cannot reach the cooling water quality. However, first results showed the effective retention of microorganisms such as *Escherichia coli* and *Legionella*. After RO treatment, nearly all parameters reached the quality that is required for





cooling water. Only the pH and the calcium concentration were too low. Therefore, a typical post-treatment for RO permeate such as a chemical stabilisation can be used to meet the requirements for cooling water and to prevent corrosion in the water distribution system.

The water quality for steam production cannot be reached with the current setting of the pilot plant alone. A post-treatment for the RO permeate such as an ion exchanger is required to decrease the concentrations of sodium, potassium and silicate as well as the electrical conductivity. However, this treatment stage is usually present at the industries using steam. Thus, the challenge here is the chemical stabilisation for the supply of water to the industries as this slightly increases also the hardness.

Overview about the *ULTIMATE* laboratory and pilot plant results status (November 2022). ✓ means that these results are included in the present Deliverable.

Case Study	Subtask	Technologies or treatment train	Laboratory results	Pilot plant results
1	1.2.1.	Ultrafiltration, reverse osmosis, membrane distillation, adsorption on zeolites	✓	12 m ³ /day pilot plant in operation in November 2022, not results yet
2	1.2.2.	Capacitive Electrodialysis	Yes	✓ 0.1 m ³ /day pilot plant in operation
	1.3.1	High temperature aquifer thermal energy storage	No	Tests on going, not results yet
	1.4.1	Nutrients recovery	Yes	✓ 0.1 m ³ /day pilot plant in operation
3	1.2.3	Control system to avoid high chlorine concentrations	No	No
	1.4.2	Adsorption	✓	✓ 0,5 – 3,5 m ³ / pilot plant
4	1.2.4	Filtration, advanced oxidation process, small bioreactor platform	✓	10 m ³ /day pilot plant in operation, not results yet
	1.4.3	Adsorption/extraction	✓	
	1.2.5	Nanofiltration, reverse osmosis, advanced oxidation processes, ultraviolet	Yes	✓ 2 m ³ /h pilot plant in operation
		Anaerobic Membrane Reactor	No	It will be commissioned December 2022
		ELSAR	Yes	✓





Case Study	Subtask	Technologies or treatment train	Laboratory results	Pilot plant results
5	1.3.2			20 m ³ /h pilot plant
		SOFC	No	It will be commissioned December 2022
	1.4.4	Recovery nutrients from digestate	Concept study	
Solar driven hydrothermal carbonization		No	Yes	
6	1.3.3	Advanced Anaerobic Treatment (Karmiel)	No	✓ 120 m ³ /day
	1.3.4	Advanced Anaerobic Treatment (Shafdan)	No	12-24 m ³ /day pilot plant in operation, not results yet
	1.4.5	Adsorption (Karmiel)	No	120 m ³ /day pilot plant in operation, not results yet
7	1.2.6	AnMBR and reverse osmosis	No	1 m ³ /day pilot plant commissioned but not in operation
	1.3.5	AnMBR and heat utilization	No	
	1.4.6	Precipitation and stripping/scrubbing	No	✓ 1 m ³ /h pilot plant
8	1.3.6	Heat recovery	Concept study	
	1.4.7	Absorption	✓	500 Nm ³ /h fumes pilot plant in operation April 2023
9	1.2.7	Ultrafiltration	No	✓
	1.3.7	Joint control system	Modelling task	
	1.4.8	High added value compounds recovery	Concept study	

Exploitation and Outlook

This deliverable presents the status of the case studies related to the pilot plant activities.

It should be remarked that CS1, CS2, CS3, CS4, CS8 have one unique pilot plant, but CS5, CS6 and CS9 have two or more pilot plants, which translates into more challenges when designing, building, commissioning, and operating them.

On the other hand, most of the case studies have the pilot plant built and commissioned, but due to delays, not all of them are in operation. Furthermore, other pilot plants are still being designed or not completely ready to be operated.





Considering this global overview, this deliverable collects preliminary results at laboratory scale or pilot plant scale, depending on the case study and its situation in November 2022. The case studies will continue working on the operation of the different technologies and the experimental results will be further completed during the next months.

At the end of ULTIMATE project, obtained results for water, energy and material technologies will be included in D1.3, D1.4 and D1.5 respectively.

Disclaimer

This publication reflects only the author's view and the European Union is not liable for any use that may be made of the information contained therein.





Table of Contents

ABBREVIATIONS	22
1. INTRODUCTION	24
2. START-UP AND INTERMEDIATE RESULTS OF PLANT OPERATION	26
2.1. CS1 TARRAGONA (SPAIN).....	28
2.1.1. BRIEF DESCRIPTION OF THE CASE STUDY AND OBJECTIVES.....	28
2.1.2. TECHNOLOGICAL SOLUTION IN ULTIMATE PROJECT: PILOT PLANT DESCRIPTION ...	31
2.1.3. START-UP OPERATION.....	35
2.1.4. RESULTS FROM LABORATORY TESTS AND DISCUSSION	36
2.1.5. CASE STUDY MAIN CONCLUSIONS.....	46
2.2. CS2 NIEUW PRINSENLAND (NETHERLANDS).....	46
2.2.1. BRIEF DESCRIPTION OF THE CASE STUDY AND OBJECTIVES.....	46
2.2.2. TECHNOLOGICAL SOLUTION IN ULTIMATE PROJECT: PILOT PLANT DESCRIPTION ...	49
2.2.3. START-UP OPERATION.....	50
2.2.4. RESULTS FROM PILOT PLANT OPERATION AND DISCUSSION.....	52
2.2.5. HT-ATES FEASIBILITY – EXPERIMENTAL WORK.....	53
2.2.6. CASE STUDY MAIN CONCLUSIONS.....	58
2.3. CS3 ROSIGNANO (ITALY)	58
2.3.1. BRIEF DESCRIPTION OF THE CASE STUDY AND OBJECTIVES.....	58
2.3.2. TECHNOLOGICAL SOLUTION IN ULTIMATE PROJECT: PILOT PLANT DESCRIPTION ...	60
2.3.3. START-UP OPERATION.....	63
2.3.4. RESULTS FROM LABORATORY AND PILOT PLANT OPERATION AND DISCUSSION	64
2.3.5. CASE STUDY MAIN CONCLUSIONS.....	74
2.4. CS4 NAFPLIO (GREECE)	75
2.4.1. BRIEF DESCRIPTION OF THE CASE STUDY AND OBJECTIVES.....	75
2.4.2. TECHNOLOGICAL SOLUTION IN ULTIMATE PROJECT: PILOT PLANT DESCRIPTION ...	76
2.4.3. START-UP OPERATION.....	80
2.4.4. RESULTS FROM LABORATORY SCALE TESTS AND DISCUSSION	81





2.4.5.	CASE STUDY MAIN CONCLUSIONS.....	83
2.5.	CS5 LLEIDA (SPAIN)	83
2.5.1.	BRIEF DESCRIPTION OF THE CASE STUDY AND OBJECTIVES	83
2.5.2.	TECHNOLOGICAL SOLUTION IN ULTIMATE PROJECT: PILOT PLANT DESCRIPTION ...	84
2.5.3.	START-UP OPERATION.....	101
2.5.4.	RESULTS FROM PILOT PLANT OPERATION AND DISCUSSION	104
2.5.5.	CASE STUDY MAIN CONCLUSIONS.....	117
2.6.	CS6 KARMIEL AND SHAFDAN (ISRAEL)	119
2.6.1.	BRIEF DESCRIPTION OF THE CASE STUDY AND OBJECTIVES	119
2.6.2.	TECHNOLOGICAL SOLUTION IN ULTIMATE PROJECT: PILOT PLANT DESCRIPTION .	119
2.6.3.	START-UP OPERATION.....	122
2.6.4.	RESULTS FROM PILOT PLANT OPERATION AND DISCUSSION	123
2.6.5.	CASE STUDY MAIN CONCLUSIONS.....	125
2.7.	CS7 TAIN (UNITED KINGDOM)	125
2.7.1.	BRIEF DESCRIPTION OF THE CASE STUDY AND OBJECTIVES	125
2.7.2.	TECHNOLOGICAL SOLUTION IN ULTIMATE PROJECT: PILOT PLANT DESCRIPTION .	127
2.7.3.	START-UP OPERATION.....	130
2.7.4.	RESULTS FROM PILOT PLANT OPERATION AND DISCUSSION	130
2.7.5.	CASE STUDY MAIN CONCLUSIONS.....	137
2.8.	CS8 CHEMICAL PLATFORM OF ROUSSILLON (FRANCE).....	138
2.8.1.	BRIEF DESCRIPTION OF THE CASE STUDY AND OBJECTIVES	138
2.8.2.	TECHNOLOGICAL SOLUTION IN ULTIMATE PROJECT: PILOT PLANT DESCRIPTION .	139
2.8.3.	START-UP OPERATION.....	141
2.8.4.	RESULTS FROM PILOT PLANT OPERATION AND DISCUSSION	142
2.8.5.	CASE STUDY MAIN CONCLUSIONS.....	145
2.9.	CS9 KALUNDBORG (DENMARK)	146
2.9.1.	BRIEF DESCRIPTION OF THE CASE STUDY AND OBJECTIVES	146
2.9.2.	TECHNOLOGICAL SOLUTION IN ULTIMATE PROJECT: PILOT PLANT DESCRIPTION .	146





2.9.3.	START-UP AND OPERATION OF MEMBRANE PILOT PLANTS	148
2.9.4.	LABORATORY RESULTS FROM PILOT PLANT OPERATION AND DISCUSSION	151
2.9.5.	CASE STUDY MAIN CONCLUSIONS.....	157
3.	CONCLUSIONS	158
4.	REFERENCES	162





Table of tables

Table 1. ULTIMATE case studies and symbioses with their resources for circular economy concepts regarding water, energy, and material (WWTP: wastewater treatment plant; SME: small and medium enterprise providing water services; WRP: water reclamation plant).	24
Table 2. Overview about the ULTIMATE solutions: relevant for D1.9 are the blue-, green- and yellow-coloured technologies.....	26
Table 3. Overview about the ULTIMATE laboratory and pilot plant results status (November 2022).....	27
Table 4. Water quality requirements for reuse in cooling towers according to Spanish Royal Decree 1620/2007 (section 3.2.a.).....	29
Table 5. Water quality limits for reclaimed water in Tarragona WRP.	29
Table 6. CS1 pilot plant treatment capacities.....	34
Table 7. Feed, permeate and concentrate turbidity and COD values (1000 kDa ceramic membrane and 80% recovery).	38
Table 8. UF tests results with two different tubular membranes at 90% recovery.	39
Table 9. Feed, permeate and concentrate analysis at 90% recovery.....	39
Table 10. Feed, permeate and concentrate analysis at 90% recovery with Likuid 100 kDa membrane.	40
Table 11. Selection of reverse osmosis membrane: brackish vs seawater.	40
Table 12. Permeate quality with Toray flat sheet at 40 bar and 75% recovery.....	41
Table 13. Membrane distillation experimental results.	42
Table 14. Ammonium adsorption on zeolites batch tests results.....	43
Table 15. Ammonium adsorption capacity obtained with breakthrough curves.	45
Table 16. Ammonium adsorption capacity obtained with breakthrough curves.	45
Table 17. ED pilot operating conditions.	50
Table 18. Design parameters of the adsorption columns.....	60
Table 19. Standard specifications - CSC5.	63
Table 20. Experimental condition of chemical activation and slow pyrolysis of hydrochar....	65
Table 21. Leaching test using Hydrochar (HC) and Activated Hydrochar (AH).	66
Table 22. BET Surface Area of Hydrochar (HC), Activated Hydrochar (AH), Pyrolyzed Hydrochar (PH) and commercial Granular Activated Carbon (GAC).....	68
Table 23. Operative conditions of slow pyrolysis performed at pilot scale.....	70
Table 24. Wastewater for start-up operation.....	80
Table 25. Start-up operation conditions.	81
Table 26. Water quality requirements for reuse in cooling towers according to Royal Decree 1620/2007 (section 3.2.a).....	85
Table 27. Characteristics of the membrane module.....	91





Table 28. Characterization of the brewery wastewater in July 2020. Based on 28 24h-integrated samples.	93
Table 29. Sanitation requirements on the 4 th draft of EU 86/278/CEE.....	101
Table 30. Analytical programme for each trial for dewatered and thickened sludge. For compost, sampling was done only for 0, 10 and 120 minutes. Except for sample “0”, the time in minutes or hours refers to the time after the objective temperature has been reached (e.g., 80°C).	103
Table 31. Average data ± standard deviation between February and September 2022 of the currents of the different stages of the regeneration test at Mahou San Miguel. Highlighted in green and orange, the parameters that meet or fail, respectively, the reuse requirements.	104
Table 32. Summary of average operational results obtained in various configurations tested in the NF plant: permeability (corrected at 20°C), pressure difference (pressure increase due to accumulation of solids (clogging), temperature of the water to be treated and conductivity of the water to treat.	107
Table 33. Microbial inactivation performance in compost samples after 10 minutes at a temperature ca. 80°C.	117
Table 34. Characteristics of the AnMBR effluent.	131
Table 35. Operational parameters and performance of the precipitation unit during the initial phase of testing (September to November 2022).	132
Table 36. Elemental analysis (as % weight) by Energy-dispersive X-ray spectroscopy (EDS) of selected areas on different pellets recovered from the reactor.....	136
Table 37. Tests carried out.	141
Table 38. Tested operational parameter, preferred settings (bold) and measured TMP (for preferred settings).	149
Table 39. Maintenance effort/trouble shooting for a continuous pilot plant operation.	149
Table 40. Different water qualities after the treatment with different membrane types: conventional UF (UF), ultra-tight UF, open NF and RO compared to the required quality for cooling water according to RD1620/2007; VDI 3803 and Demoware D1.3 (Niewersch et al. 2016).	154
Table 41. Different water qualities after the treatment with different membrane types: conventional UF (UF), ultra-tight UF, open NF and RO compared to the required quality for steam production according to EN-12952-12, boiler feed water.....	156





Table of figures

Figure 1. Petrochemical complex of Tarragona (Spain).....	29
Figure 2. Scheme of the pre-existing system and the partners of the symbiosis before the start of ULTIMATE.	30
Figure 3. ULTIMATE CS1 global overview.	31
Figure 4. CS1 pilot plant process scheme.	32
Figure 5. CS1 pilot plant installed in AITASA facilities.	35
Figure 6. Sieves used to filter real water from industrial complex discharge network.....	37
Figure 7. Ultrafiltration experimental set-up. Left: ceramic membrane (1000 kDa), right: polymeric membrane (150 kDa).	37
Figure 8. UF permeability at 80% recovery (feed= 25 L) and ceramic membrane. Left: first batch, right: second batch.	38
Figure 9. UF permeability at 90% recovery (feed= 25 L). Left: 1000 kDa ceramic membrane, right: 150 kDa polymeric membrane.	38
Figure 10. UF permeability, recovery and flux for ceramic membrane Likuid 100 kDa.....	39
Figure 11. Reverse Osmosis laboratory experimental set-up.....	40
Figure 12. Reverse Osmosis tests with Toray flat sheet membrane at P=40 bar.....	41
Figure 13. Membrane distillation laboratory experimental set-up.....	42
Figure 14. Membrane distillation flux tests: $\Delta T=60^{\circ}\text{C}$ (left), and $\Delta T= 70^{\circ}\text{C}$ (right).....	42
Figure 15. Membrane distillation flux tests: $\Delta T=70^{\circ}\text{C}$ and 35 g NaCl/L feed solution.	43
Figure 16. Zeolite adsorption column experimental set-up.....	44
Figure 17. ZN Aqua ammonium break-through curves at different contact times.....	44
Figure 18. Ammonium adsorption after regeneration.....	45
Figure 19. Energetic interaction between the agro- and food cluster in Nieuw-Prinsenland area.	47
Figure 20. Treatment plant De Vlot.....	48
Figure 21. The proposed technological solutions from ULTIMATE in the water system at De Vlot (ULTIMATE addition indicated in purple).	48
Figure 22. PID of the ED stack and pilot installation.	50
Figure 23. ED pilot installation.	51
Figure 24. Data logging system in the CED pilot.....	51
Figure 25. Specific energy consumption (kWh/m^3) as a function of recovery (%) and conductivity of the recovered water (mS/cm) for synthetic (left) and real (right) greenhouse wastewater experiments.....	52
Figure 26. Change in conductivity over different voltages in the diluate and concentrate for the synthetic greenhouse wastewater CED pilot runs.....	52
Figure 27. Schematic representation of the deepening drilling as carried out at the TRIAS Westland site.....	54
Figure 28. Picture of the coring device that was used to obtain the core samples.	56





Figure 29. Lithological interpretation and well completion information from 145 to 275 m depth, based on the logging data and cuttings description. 57

Figure 30. ARETUSA WRP in Rosignano WWTP Area. 59

Figure 31. PID of the adsorption pilot plant. 61

Figure 32. Adsorption pilot plant. 62

Figure 33. Calibration curve of fluorescence meter. 64

Figure 34. Fluorescence spectra of influent, effluent, and mixed (influent/effluent) samples collected in the monitoring tank of the adsorption pilot plant. 64

Figure 35. Washing tests in columns filled with Hydrochar (HC) and Pyrolyzed Hydrochar (PH). Monitored parameters included UV absorbance at 254 nm (a), conductivity (b), pH (c) and COD (d). 67

Figure 36. SEM analysis of commercial Granular Activated Carbon (GAC), Hydrochar (HC), washed Hydrochar, Activated Hydrochar (AH) and Pyrolyzed Hydrochar (PH). 68

Figure 37. Kinetic adsorption tests for a) COD removal from wastewater, and b) DCF by using GAC, AH and PH. COD concentration was 84 mg/l for GAC test, 70 mg/l for AH test and 65 mg/l for PH test. Diclofenac concentration was 60 mg/l for all tests. Adsorbents dosages: 0.1 g of GAC, 0.1 g of AH and 0.05 g of PH. 69

Figure 38. Rotary kiln for slow pyrolysis (PYROCK). 69

Figure 39. Pyrolyzed Hydrochar. 70

Figure 40. Pressure trend before (a) and after (b) maintenance of the relief valve. 71

Figure 41. Flowrate trend during the pilot plant operation. 71

Figure 42. UV and Fluorescence trend. 72

Figure 43. UV and Fluorescence laboratory measurements on influent and effluent samples from the pilot plant. 72

Figure 44. Comparison between laboratory and sensors measurements of fluorescence at ex/em 325/445 nm and UV absorbance at 254 nm. 73

Figure 45. Monitored breakthrough for DOC and some emerging contaminants at the adsorption pilot system. 73

Figure 46. CS4 pilot plant deployed at Alberta S.A. 76

Figure 47. Layout of the pilot process deployed at Alberta S.A. 77

Figure 48. VAC adsorption process, VAC adsorption laboratory scale unit and VAC adsorption pilot sub-unit. 77

Figure 49. CS4 photocatalytic reactor. 79

Figure 50. SPB capsules. 79

Figure 51. CS4 pilot plant sensors, control unit and TOC analyzer. 80

Figure 52. Effect of various extraction solvents in the recovery of VACs from sorbent material. 81

Figure 53. Pre-treatment steps of orange production line by-product. 82

Figure 54. Degradation of a model organic compound using the CPC solar reactor. 82

Figure 55. Top: Removal rate of organic matter and microbial indicators in 400 and 800Da NF membranes, respectively, at a given recovery rates. Bottom: Removal rate of minerals and





electrical conductivity in 400 and 800Da NF membranes, respectively, at a given recovery rates. 86

Figure 56. Scheme of the proposed water reclamation solution in CS5. 87

Figure 57. Pictures of RO (left) and NF (right) pilot plants used for the water reclamation case in CS5. 87

Figure 58. Weekly evolution of NF pilot plant conditions in CS5. 88

Figure 59. Picture comparison of the three different streams: wastewater after secondary treatment, nanofiltration and reverse osmosis. 88

Figure 60. Diagram of filtration cycles with hydraulic (HC) and chemical (CEC) cleaning. ... 88

Figure 61. Drawing of the RO pilot plant used for CS5 water reclamation case. 89

Figure 62. Top: photocatalytic reactor with support and first (white) PLA prototypes. Bottom: three sections of the UV lamp, where toroidal structures can be inserted. 90

Figure 63. Diagram of the lab-scale UV+AOP plant. 90

Figure 64. 3D drawing of the AnMBR. 1) Biological reactor 2) Membranes 3) Blower and recirculation pumps 4) Ventilator 5) Buffer tank 6) Screen 7) Stirrer 8) Electrical cabinet 9) Backwash and permeate tanks 10) Office 11) Inert gas. 91

Figure 65. Water (top) and biogas (bottom) flow diagram of the AnMBR process. 92

Figure 66. Methane production evolution in the Biochemical methane potential (BMP) conducted using brewery wastewater. 94

Figure 67. Schematic overview of pre-commercial size ELSAR®. 95

Figure 68. 3D overview of the precommercial size ELSAR®. Micropiles, concrete deck and metallic structure on both vertical tanks can be seen. Mobile concrete barriers to protect vehicular collision can also be seen. 96

Figure 69. Picture of the ELSAR® pilot plant. 97

Figure 70. 3D drawing of the SOFC pilot plant. 98

Figure 71. Pictures of the side (left) and entrance (right) of the (bio) fuel cell pilot plant. 99

Figure 72. Top, left: 3D view of the sun module. Top, right: front view. Bottom, left: picture of the solar-based pilot plant in the WWTP. Bottom, right: Detail of the receptacle where lays the sludge bed. 100

Figure 73. 3D drawing of the module in maintenance mode. 101

Figure 74. Turbidity [FTU, black], Temperature [°C, green], pH [-, purple] and Feed conductivity [µS/cm, pink] evolution in the inlet treated wastewater between February and August 2022. 105

Figure 75. Weekly evolution of average permeability and average pressure drop. 105

Figure 76. Evolution of recovery, flow, permeability, pressure difference (pressure increase due to accumulation of solids (clogging)) and transmembrane pressure (red) between February and August 2022 in the nanofiltration pilot plant. 106

Figure 77. Scaling risks considering the average mineral content on treated water. 108

Figure 78. Some thermoplastic particles and dust were observed after first Aqualia's tests, proving that resistance of the structure had to be improved, although the reasons of these damages were not fully understood. Samples were sent to the CSP supplier. 108





Figure 79. Time evolution of absorbance of the water at 288nm (top) and diclofenac concentration (bottom) in different tests in AOP+UV batch tests. The batch tests start at t=0. 109

Figure 80. Left: Detail of a draft “tube-based” configuration of anodic and cathodic collectors, rejected because of its complexity, its low electrode surface and its high fabrication cost. Right: real picture of the prototype of the collectors (anodic and cathodic) to be tested in the ELSAR® prototype in January 2023. Electrode plates are less than 2mm thick, minimizing weight and material cost, and maximizing electrode surface. 110

Figure 81. General geometry overview (left) and subunit modelling (right) of the model CFD of the bottom of the ELSAR reactor. 111

Figure 82. Influence of the size & density in the bed expansion, according to the CFD model. Both consider the biogas production. Left: big size diameter (1.3mm), right: low sludge density 1050 kg/m³. 112

Figure 83. Example of V30 (settling of 1L sample after 30 minutes) in a normal wastewater sample (left) vs. a wastewater containing a very high amount of suspended matter (right). 113

Figure 84. Top: Dry matter evolution in thermosolar batch tests with sludge (left) and compost (right). Bottom. Volatile matter evolution in thermosolar batch tests with sludge (left) and compost (right). DH = dewatered WWTP sludge; ESP = thickened sludge; Compost samples: “m” means month of composting age. 114

Figure 85. Correlation between drying rate and type of water bindings in biosolids [5]. 115

Figure 86. Evolution of Escherichia coli and Clostridium perfringens in sludge samples exposed to a thermosolar-based drying system at temperatures >80°C. 116

Figure 87. Summary of low-temperature hydrolysis of waste activated sludge [11]. 117

Figure 88. Schematic description of biogas production (Scenario 1) and polyphenols recovery (Scenario 2). 120

Figure 89. Schematic description of Shafdan system). 121

Figure 90. PID of the Shafdan system. 122

Figure 91. Total COD as a function of time after the AAT at the Karmiel system. 123

Figure 92. Biogas flow and temperature as a function of time from the AAT at the Karmiel system. 124

Figure 93. Total suspended solids (TSS) as a function of time after the AAT in the Karmiel system. 124

Figure 94. Pre-existing system at the distillery before the start of ULTIMATE. 126

Figure 95. Struvite precipitation unit ((a) precipitation reactor and (b) clarifier). 128

Figure 96. Ammonia stripping/scrubbing unit. 129

Figure 97. Reverse osmosis unit. 130

Figure 98. Scaling of the (a) internal part of the feed pump, (b) pipes, (c) chemical dosing points and (d) probes. 134

Figure 99. Samples collected form the different sections of the reactor A to D, from bottom to top. 135

Figure 100. Scanning electron microscope images of the struvite pellets harvested after the first trial (pH = 8.3, Mg:P 1.3:1). 135





Figure 101. Scanning electron microscope images of the struvite pellets harvested in the later trial (pH = 7.7-8.5, Mg:P 1:1). 136

Figure 102. Example of X-ray diffraction spectrum for the pellets recovered from the reactor (black) matching closely the standard for struvite (red). 137

Figure 103. The Roches-Roussillon chemical platform. 138

Figure 104. Principle of the industrial pilot. 140

Figure 105. Diagram of the laboratory pilot. 141

Figure 106. Evolution of the absorption efficiency as a function of the time 142

Figure 107. Evolution of time to reach an absorption efficiency of 90 % as a function of the initial concentration. 143

Figure 108. Evolution of the absorption efficiency as a function of the pH. 143

Figure 109. Evolution of the absorption efficiency as a function of the time for different percentage of SO₂ at the second concentration tested in the absorption liquid 144

Figure 110. Evolution of the absorption efficiency as a function of the time for different percentage of SO₂ at the first concentration tested in the absorption liquid 144

Figure 111. Evolution of the absorption efficiency as a function of pH for different percentage of SO₂ at the first concentration tested in the absorption liquid 144

Figure 112. Evolution of the absorption efficiency as a function of pH for different percentage of SO₂ at the second concentration tested in the absorption liquid 144

Figure 113. Evolution of the absorption efficiency as a function of the time at different temperature. 145

Figure 114. Composition of the outlet of the secondary clarifier of the municipal WWTP and upstream of the final ozonation unit. 147

Figure 115. Pilot container A and B with pre-treatment, tanks, membrane units and water streams. 147

Figure 116. Pilot A - left: conventional ultrafiltration module; Pilot B - middle: reverse osmosis units and right: novel UF/NF module. 148

Figure 117. Tested treatment trains. 148

Figure 118. Retention of selected water quality parameters using different membrane types. 151

Figure 119. Retention of different water quality parameters using reverse osmosis. 152





Abbreviations

AAT	Advanced Anaerobic Technology
AEM	Anion Exchange Membrane
AH	Activated Hydrochar
AnMBR	Anaerobic Membrane Reactor
AOP	Advanced Oxidation Process
BDO	Biological Oxygen Demand
BMP	Biomechanical Methane Potential
CED	Capacitive Electrodialysis
CEM	Cation Exchange Membrane
CFD	Computational Fluid Dynamics
CIP	Clean-in-Place
COD	Chemical Oxygen Demand
CS	Case Study
CSP	Ceramic Supported Photocatalyst
DFC	Diclofenac
ED	Electrodialysis
ELSAR	Electrostimulated Anaerobic Reactor
GAC	Granular Activated Carbon
HC	Hydrochar
HRAR	High Rate Anaerobic Reactor
HT-ATES	High Temperature Aquifer Thermal Energy Storage
HTC	Hydrothermal carbonization
IC	Internal Combustion
IEM	Ion Exchange Membrane
iWWTP	Industrial Wastewater Treatment Plant
MD	Membrane Distillation
MVM	Monovalent Selective Membranes
MWCO	Molecular Weight Cut-off
NF	Nanofiltration
nZLD	Near Zero Liquid Discharge
OMW	Olive Mill Wastewater
PH	Pyrolized Hydrochar





PID	Piping and Instrumentation Diagram
RO	Reverse Osmosis
SBP	Small Bioreactor Platform
SCWE	Subcritical Water Extraction
SGR	Spectral Gamma Ray
SOFC	Solid Oxide Fuel Cell
SPR	Single Point Resistance
TS	Total Solids
TVS	Total Volatile Solids
UF	Ultrafiltration
UV	Ultraviolet
VAC	Value Added Compound
WRP	Water Reclamation Plant
WSIS	Water Smart Industrial Symbioses
WWTP	Wastewater Treatment Plant
ZLD	Zero Liquid Discharge





1. Introduction

Wastewater can act as a reusable resource as well as a vector for energy and materials to be extracted, treated, stored, and reused. The EU-funded ULTIMATE project will operate as a catalyst for Water Smart Industrial Symbiosis (WSIS), in which water/wastewater plays a key role within a dynamic socio-economic and business oriented industrial ecosystem.

ULTIMATE is focused on water smart industrial symbioses (WSIS) between the industrial sector and services providers of the water sector. The WSIS approach is considered to be the basis for a successful implementation of circular economy technologies, because one partner produces the resource for the circular economy solution and the other partner has the demand for the recovered product. Thus, they cooperate for their mutual benefits.

ULTIMATE will demonstrate the multiple uses of municipal and industrial wastewater through nine high-level demonstrations in Europe and the south-eastern Mediterranean from the agro-food processing, beverage, heavy chemical/petrochemical, and biotech industries. It will recover, treat, and reuse industrial and municipal wastewater, derive, and exploit energy, and extract valuable materials contained in industrial wastewater, developing, and demonstrating different technologies, as it can be seen in Table 1. It will also advance innovative collaborations between businesses, water service providers, regulators, and policymakers for a more circular and socially responsible industry.

Table 1. ULTIMATE case studies and symbioses with their resources for circular economy concepts regarding water, energy, and material (WWTP: wastewater treatment plant; SME: small and medium enterprise providing water services; WRP: water reclamation plant).

Case study	Water Smart Industrial Symbioses	Resources	Closing the cycles of WATER, ENERGY, MATERIAL		
CS1 Tarragona (ES)	Internal symbiosis within multi-industry utility: municipal and industrial WWTP & urban WRP	Municipal wastewater and industrial wastewater from the petrochemical complex	✓		
CS2 Nieuw Prinsenland (NL)	Internal symbiosis within cooperative: greenhouses & water treatment facility	Drain water from greenhouses; residual and geothermal heat	✓	✓	✓
CS3 Rosignano (IT)	Municipal utility, multi-industry utility & SME: Sewer system, municipal WWTP, WRP	Municipal wastewater mixed with seawater due to an undesired intrusion of the seawater; byproducts from industry for reuse in water treatment	✓		✓
CS4 Nafplio (EL)	Industrial utility & SME: industrial WWTP	Wastewater from fruit processing industry	✓		✓
CS5 Lleida (ES)	Municipal utility & multi-industry utility:	Wastewater from brewery & municipal wastewater	✓	✓	✓





Case study	Water Smart Industrial Symbioses	Resources	Closing the cycles of WATER, ENERGY, MATERIAL		
CS6 Karmiel/ Shafdan (IL)	industrial WWTP & municipal WWTP Municipal utility & two SMEs: two municipal WWTPs & WRP	Wastewater from olive oil production, slaughter houses and wineries & municipal wastewater			
CS7 Tain (UK)	Distillery, water company, & SME: industrial WWTP	Wastewater from whiskey distillery			
CS8 Chem. Platform Roussillion (FR)	Internal symbiosis within multi-industry utility: industrial WWTP	Wastewater from chemical industry			
CS9 Kalundborg (DK)	Municipal utility & multi-industry utility: municipal WWTP & industrial WWTP	Wastewater from pharma & biotech industry and municipal wastewater			

As it can be checked in table above, not all the nine case studies are focused in closing the cycles of water, energy, and material recovery. For this reason, different pilot plants have been designed and built to demonstrate the feasibility of different technologies, depending on the final purpose and objectives of each case study, as it can be seen in Table 2.





Table 2. Overview about the ULTIMATE solutions: relevant for D1.9 are the blue-, green- and yellow-coloured technologies.

CS Name	Water Smart Industrial Symbiosis						Explanation of colour code/scale indication		
	Industrial Sectors	Service Providers					WATER RECLAMATION AND REUSE	NUTRIENT & MATERIAL RECOVERY & REUSE	ENERGY & HEAT RECOVERY & REUSE
	Agrifood Beverage	Chemical/Petrochemical	BioTech	Municipal utility	Multi-industry utility	Specialist SME providing water services	NO PILOT PLANT --> NOT PART OF D1.2	COMBINATION OF THE CS4 PILOT PLANTS FOR WATER & MATERIAL	
Technologies applied & Circular Economy contributions									
1	Tarragona (ES)						Zeolite adsorption for ammonia removal from urban reclaimed water, reducing energy consumption of urban WWTP TRL 5 → 6	nZLD systems (membranes) for industrial water reuse TRL 5 → 7	Concept study for integration of urban and reclaimed water production for industrial water use TRL 4 → 6
2	Nieuw Prinsenland (NL)						Water treatment solution for recycling of drainwater from greenhouses allowing safe reuse in horticulture TRL 4 → 6	Closed loop greenhouses with water and nutrient recycling TRL 4 → 6	HT-ATES for use in greenhouse horticulture to balance out energy supply and demand using industrial residual heat TRL 5 → 7
3	Rosignano (IT)						Real-time data driven process control for salinity management to improve reclamation yield from municipal WWTP TRL 5 → 7	Data-driven matchmaking platform for water reuse of water from various sources TRL 5 → 7	Use of industrial byproducts as wastewater treatment process chemicals in ARETUSA reclamation plant TRL 4 → 7
4	Nafplio (EL)						Water reuse in industry after filtration, adsorption, super critical water extraction & AOP TRL 5 → 7	Mobile wastewater treatment unit for use in seasonal food processing industry combing both water recovery and material recovery units TRL 5 → 7	Extraction of value added compounds from fruit processing wastewater by filtration, adsorption and supercritical fluid extraction TRL 5 → 7
5	Lleida (ES)						Water reuse after treatment with AnMBR and ELSAR with fit-for-purpose post-treatment: NF & RO: TRL 7 → 9; ADP & UV: TRL 7 → 9; Online Monitoring: TRL 5 → 7	Concept study for nutrient recovery via digestate application in agriculture TRL 5 → 7 Solar-driven hydrothermal carbonisation plant for biochar production TRL 5 → 6	Increased yield in biogas production in anaerobic membrane bioreactors AnMBR: TRL 7 → 9 ELSAR: TRL 5 → 7 and biogas valorisation: SOFC: TRL 7 → 9
6	Karmiel, Shafdan (IL)						Shafdan: Combined immobilised high rate anaerobic filter (AAT) with membrane filtration and activated carbon (AC) for increased biogas production TRL 5 → 7	Extraction of value added products from olive mill wastewater by adsorption & supercritical fluid extraction TRL 5 → 7	Karmiel: AAT for biogas production from poorly degradable organic matter TRL 5 → 8
7	Tain, Scotland (UK)						RO treatment of AnMBR effluent for water reuse in cleaning processes at the distillery TRL 5 → 7	Ammonia recovery from distillery wastewater TRL 5 → 7 Struvite recovery TRL 5 → 7	Heat recovery from AnMBR effluent TRL 5 → 7
8	Saint Maurice, l'Exil (FR)						Flue gas scrubbing & dust removal for sulphur recovery as sodium bisulphite TRL 4 → 6	Concept study for a method to recover metals (e.g. Fe, Cu, Zn, Ni, Cr) from flue gas cleaning water TRL 4 → 6	Concept study to recover heat from the flue gas washing water for steam or electricity production TRL 2 → 4
9	Kalundborg (DK)						Combination of novel ultrafiltration membranes as pre-treatment for wastewater with high-nondegradable organic matter TRL 5 → 7	Concept study for nutrient and/or high-value product recovery (Integration of solutions of other sites with TRL > 6)	Data driven control system to increase energy efficiency through a synergetic operation of an industrial and municipal WWTP TRL 5 → 8

2. Start-up and intermediate results of plant operation

D1.9 focuses on the pilot plants being developed and demonstrated in the frame of ULTIMATE and thus, the next sections deal with the pilot plant for fit-for-purpose water, energy and nutrients recovery. This document collects information about pilot plant start-up and operation results until November 2022.





Although the majority of the pilot plants are commissioned and they are in operation, as it can be seen in Table 3, not all the case studies can present preliminary plant operation results in this deliverable due to delays in pilot plant construction and commissioning or problems during the start-up operation. Instead of results from pilot plant operation, some case studies present previous laboratory scale results.

Table 3. Overview about the ULTIMATE laboratory and pilot plant results status (November 2022).

✓ means that these results are included in the present Deliverable.

Case Study	Subtask	Technologies or treatment train	Laboratory results	Pilot plant results
1	1.2.1.	Ultrafiltration, reverse osmosis, membrane distillation, adsorption on zeolites	✓	12 m ³ /day pilot plant in operation in November 2022, not results yet
2	1.2.2.	Capacitive Electrodialysis	Yes	✓ 0.1 m ³ /day pilot plant in operation
	1.3.1	High temperature aquifer thermal energy storage	No	Tests on going, not results yet
	1.4.1	Nutrients recovery	Yes	✓ 0.1 m ³ /day pilot plant in operation
3	1.2.3	Control system to avoid high chlorine concentrations	No	No
	1.4.2	Adsorption	✓	✓ 0,5 – 3,5 m ³ / pilot plant
4	1.2.4	Filtration, advanced oxidation process, small bioreactor platform	✓	10 m ³ /day pilot plant in operation, not results yet
	1.4.3	Adsorption/extraction	✓	
5	1.2.5	Nanofiltration, reverse osmosis, advanced oxidation processes, ultraviolet	Yes	✓ 2 m ³ /h pilot plant in operation
	1.3.2	Anaerobic Membrane Reactor	No	It will be commissioned December 2022
		ELSAR	Yes	✓ 20 m ³ /h pilot plant
		SOFC	No	It will be commissioned December 2022
1.4.4	Recovery nutrients from digestate		Concept study	





Case Study	Subtask	Technologies or treatment train	Laboratory results	Pilot plant results
		Solar driven hydrothermal carbonization	No	Yes
6	1.3.3	Advanced Anaerobic Treatment (Karmiel)	No	✓ 120 m ³ /day
	1.3.4	Advanced Anaerobic Treatment (Shafdan)	No	12-24 m ³ /day pilot plant in operation, not results yet
	1.4.5	Adsorption (Karmiel)	No	120 m ³ /day pilot plant in operation, not results yet
7	1.2.6	AnMBR and reverse osmosis	No	1 m ³ /day pilot plant commissioned but not in operation
	1.3.5	AnMBR and heat utilization	No	
	1.4.6	Precipitation and stripping/scrubbing	No	✓ 1 m ³ /h pilot plant
8	1.3.6	Heat recovery	Concept study	
	1.4.7	Absorption	✓	500 Nm ³ /h fumes pilot plant in operation April 2023
9	1.2.7	Ultrafiltration	No	✓
	1.3.7	Joint control system	Modelling task	
	1.4.8	High added value compounds recovery	Concept study	

In the following chapters, each case study explains the pilot plant start-up operation details and presents laboratory or pilot plant results and their discussion.

2.1. CS1 Tarragona (Spain)

2.1.1. Brief description of the case study and objectives

The Petrochemical Complex of Tarragona (Spain) is an industrial area that groups several companies related to the chemical and oil fields. This complex started its operation in 1971, with the construction of the first refinery, and since then its activity has progressively grown until being considered one of the most important of this type in Catalonia, Spain and southern Europe. The more than 30 companies that form this complex, from which we can highlight companies like Repsol (chemical, petroleum, and gas), Bayer, BASF, ERCROS, Cepsa, Bic or The Dow Chemical Company, are mainly focused on the production of chlorine, alkaline salts, oxygen gas, fertilisers, insecticides, fuels, plastics and synthetic essences.





Figure 1. Petrochemical complex of Tarragona (Spain).

Aguas Industriales de Tarragona Sociedad Anónima (AITASA) is a private company founded in 1965 to supply water to industries, mainly the chemical industries that were then being established in the Tarragona complex. AITASA supplies water for industrial and drinking uses to the complex from groundwater and reclaimed water production.

To meet its water demands in both the industry and households, Tarragona's region has traditionally relied on water transfers from the Ebro River via a system that was built back in 1989. However, the increasing water demand from the industry outpaced the system's capacity, which led to the implementation of a reclamation plant to feed industrial water only and to avoid consuming resources of the drinking water production.

Since 2012, AITASA operates the Water Reclamation Plant (WRP) of Camp de Tarragona producing reclaimed water for boilers and cooling towers of the industry. Reclaimed water must fulfil with Spanish Royal Decree 1620/2007 that includes the water requirements to be reused in the industry.

Table 4. Water quality requirements for reuse in cooling towers according to Spanish Royal Decree 1620/2007 (section 3.2.a.).

Parameter	Requirement	Units
Legionella	Absence	CFU/1 L
Nematode eggs	<1	Eggs/10 L
Escherichia coli	Absence	CFU/100 mL
Suspended solids	<5	mg/L
Turbidity	<1	TNU

Additionally, some restrictions are established for the reclaimed water at the outlet of the WRP to be reused in cooling towers:

Table 5. Water quality limits for reclaimed water in Tarragona WRP.

Parameter	Requirement	Units
Ammonium	< 0.8	mg/L
Ortho-PO ₄	<3	mg/L





Parameter	Requirement	Units
BOD ₅	<4	mg/L
TOC	< 15	mg/L
Conductivity	2000	μS/cm

This locally available additional water supply replaces surface water supplies that were transferred from the Ebro River some years ago for the use at the petrochemical park. As a result, an equivalent volume of surface water is available for urban water supply in the coastal areas of Tarragona province.

By developing this new and locally available water supply source, industrial growth in a water scarce region has been supported, while promoting local industry's sustainability. In April 2022, an Industrial Wastewater Treatment Plant (iWWTP) was put in operation to treat industrial wastewater from the different companies of the complex. In Figure 2 it can be seen the existing system to provide reclaimed water to the petrochemical complex and the iWWTP to treat industrial wastewater from this complex.

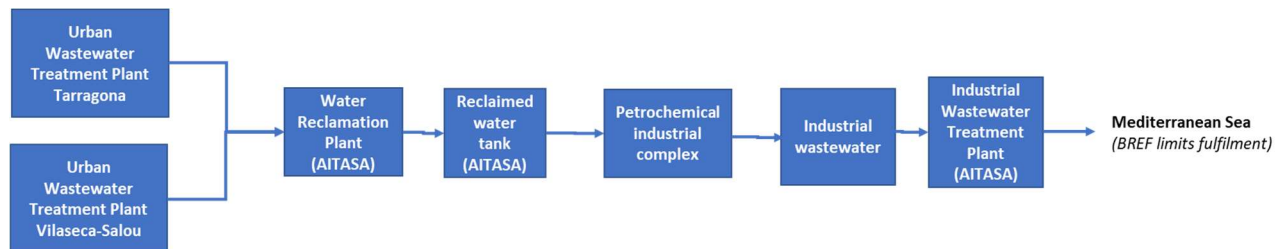

Figure 2. Scheme of the pre-existing system and the partners of the symbiosis before the start of ULTIMATE.

CS1 aims to extend the water synergies already implemented in the complex by increasing water availability for future demands with new reclaimed water production from the industrial WWTP.

The objective of CS1 is to further close the loop of water in the complex, reclaiming water from the iWWTP with near ZLD systems and optimising the current urban WRP so to maximise its water production and diminish the energy consumption. Thus, CS1 will also aim at reducing energy consumption of the current urban WRP while maximising its recovery.

New near zero liquid discharge (nZLD) treatment system

A new nZLD treatment coupling advanced reverse osmosis and membrane distillation for reclaiming water from the industrial WWTP will be demonstrated at pilot scale to obtain a new industrial water source for the complex.

Ammonium removal via a zeolite adsorption-based technology

Additionally, new low-cost treatments based on zeolite adsorption for the removal of ammonia from the current urban WRP will be demonstrated to diminish the current reclaimed water production costs and increase the water yield of the system. Those





possible zeolite treatments will be studied at bench-scale and the most economical and technically feasible will be implemented at pilot-scale

Concept study for fit-for-purpose water

The symbiosis between the industry with 30 companies and the industrially owned multi-utility will foster the integration of the industrial reclaimed water production into fit-for-purpose water production for covering the local industrial demand. Therefore, a concept study will be conducted to study the future uses of the reclaimed water.

2.1.2. Technological solution in ULTIMATE project: pilot plant description

In CS1, ULTIMATE is focused on assessing a novel tertiary treatment to treat the iWWTP outlet stream and obtain reclaimed water. A new nZLD treatment, coupling advanced reverse osmosis and membrane distillation for reclaiming water from the iWWTP, will be demonstrated at pilot scale to obtain a new industrial water source for the complex.

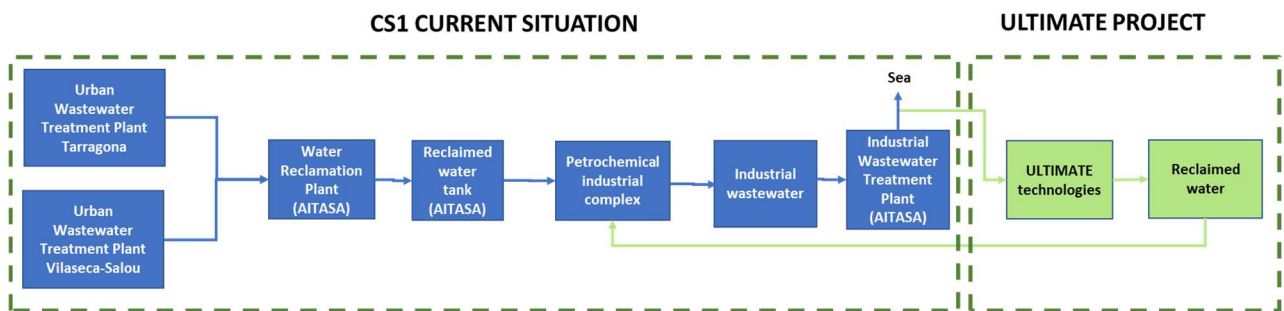

Figure 3. ULTIMATE CS1 global overview.

Four different technologies will be assessed at pilot plant scale: ultrafiltration (UF), batch reverse osmosis (RO), membrane distillation (MD) and ammonium adsorption on zeolites (Z). As it was explained before, membrane technologies train is the new nZLD solution proposed to obtain reclaimed water treating the outlet of the iWWTP. Ammonium adsorption on zeolites will be assessed as a new low-cost treatment for the removal of ammonium from the current urban WRP, that currently is removed by RO.

As it can be checked in Figure 4, the four technologies are implemented in one pilot plant.



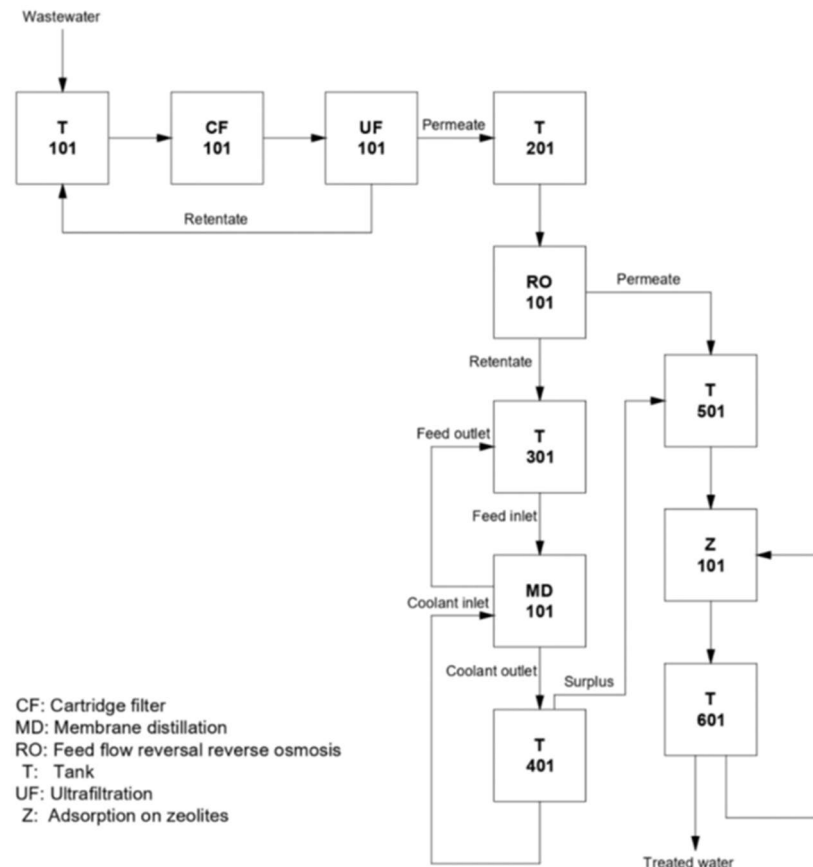

Figure 4. CS1 pilot plant process scheme.

CS1 pilot plant has been built by two different suppliers, one for the UF, RO and zeolites pilot plant, and the second for the membrane distillation pilot plant. Then, all the processes were connected in the same 40 feet maritime container.

The treatment starts from the 10 m³ tank located outside, which receives the water stream to be treated. In this tank the recirculation loop of the UF comes and enters (see Figure 5), so that in this tank as it is ultrafiltered, suspended solids are concentrated more and more, so it is equipped with an automatic emptying valve that will purge the water to allow the entry of more feed water and thus maintain a concentration of suspended solids appropriate to the parameters of the UF.

From the previous deposit part of the recirculation current of the UF by means of a horizontal centrifugal pump equipped with a frequency inverter which serves to control the flow of the recirculation loop through a PID control with the DN100 flowmeter that measures the flow of the loop. Before passing through the membranes, a 2 mm pitch mesh filter is installed to protect the entrance to the membrane tube assembly and prevent clogging of the membranes (2 membranes, Memos ME-C100-08-2995-6.2). The permeated water of the UF leaves the system towards a 5m³ tank, also located outside, from where the RO process begins.

The plant is equipped with various sensors that control the pressure such as the pressure before the mesh filter, the pressure at the inlet to the modules and the concentrate outlet pressure of the modules, permeate pressure and temperature of the UF loop in order to monitor the main plant parameters, make the PID controls as well as create the interlocks required for the protection of all the equipment that make up





the system. The UF is equipped with a system of rinsing and chemical cleaning which has a very important task which is the cleaning with clean water of the membrane modules, displacing the concentrated water of solids preventing the membranes from clogging after a stop and the cleaning by closed circuit of the membranes using basic and acidic cleaning solutions whenever the membrane requires it. The UF has a coagulant dosage to optimize the permeability of the membrane by reducing the clogging of the same and making the speeds of the loop lower.

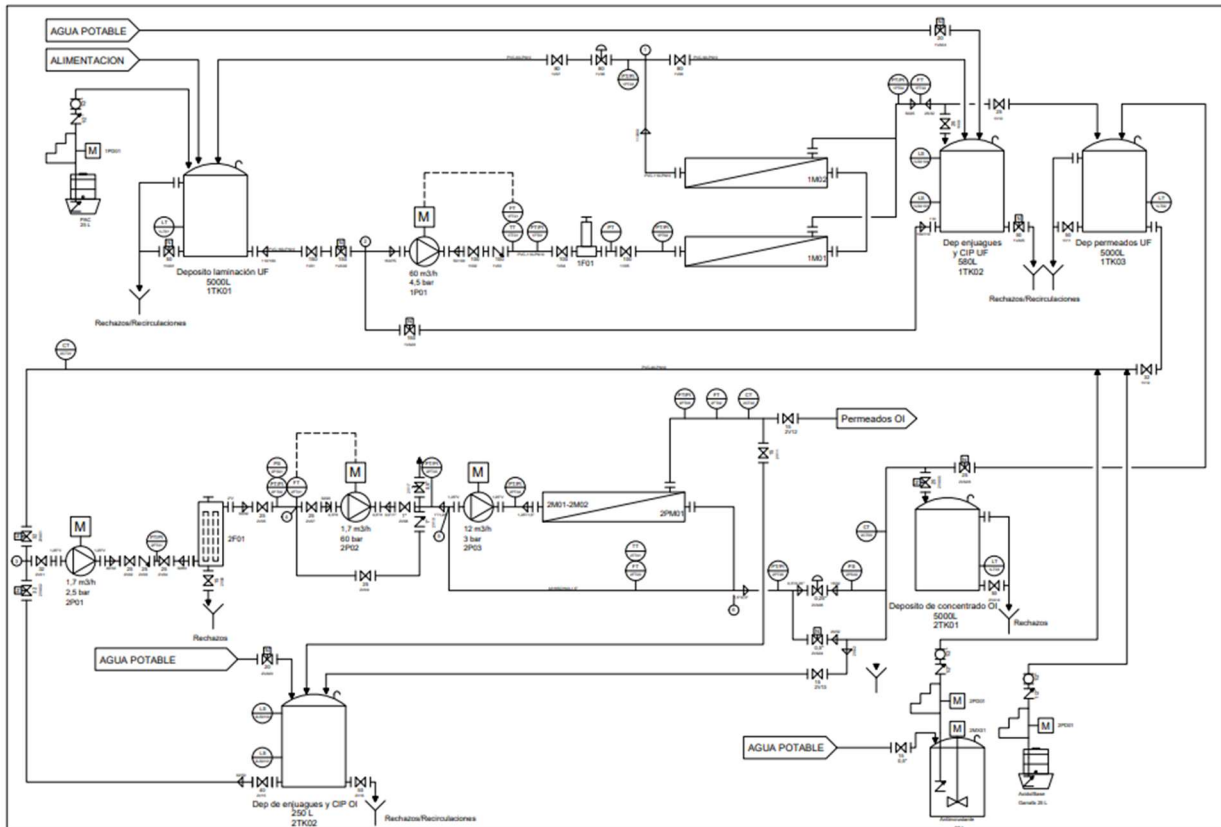

Figure 5. Ultrafiltration and batch reverse osmosis pilot plant PID scheme.

The RO starts from the permeated water tank of the UF and is carried by means of a pump to a 10 µm cartridge microfiltration to protect the modules and to space the CIP washes of the membranes. Once the filter is passed, it reaches the feed pump at a pressure of approximately 1 bar, raising the pressure to the pressure required by the RO (more or less 22 bar, or whatever the type of water requires).

This RO plant is designed with an energy recovery system which takes the concentrate current at a pressure slightly lower than the feed pressure raising it 1 or 2 bar generating a sweeping current on the feed side of the membrane (Nitto, SWC5-LD) being able to graduate the feed flow, this allows in addition to saving energy to be able to work at various feed flows. Like UF, the RO requires a rinse in case of installation shutdown and clean-in-place (CIP) washes in closed circuit periodically. The RO will have two dosages for the adequacy of feed water by an antifouling part to avoid inorganic clogging of the RO and a pump to dose either acid or base to adapt the pH to the conditions of each experiment.





Part of the RO permeate is stored in a 150 L tank to feed the zeolite column (ZN Aqua 0.5-1 mm). Inlet and outlet water samples can be taken and total water flow through the column can be measured. This part of the pilot plant is not automatized.

The MD pilot system possesses features enabling the adjustment of all relevant parameters required to acquire representative measuring data for membrane characterization, model validation, module design and feed solution investigations. The cell geometry is designed to have the smallest possible size that will still allow scalable results. Thus, the flow regime inside the cell is also suitable for heat transfer measurements. Both mean temperature and driving force temperature difference can be controlled due to the set point of the evaporator inlet and condenser outlet temperature. Without the independent possibility to vary these parameters a complete MD process analysis is not possible

The MD pilot plant is a fully automated lab unit for investigations in various MD configurations. All set points can be set through the touch screen. Connectors, vessels, sensors, and piping are constructed to be highly variable which allows experimental constructions of nearly every different type of MD. Data acquisition of process-relevant sensor values are automatically written in file while the system is running. In Figure 6 the MD pilot plant PID is shown.

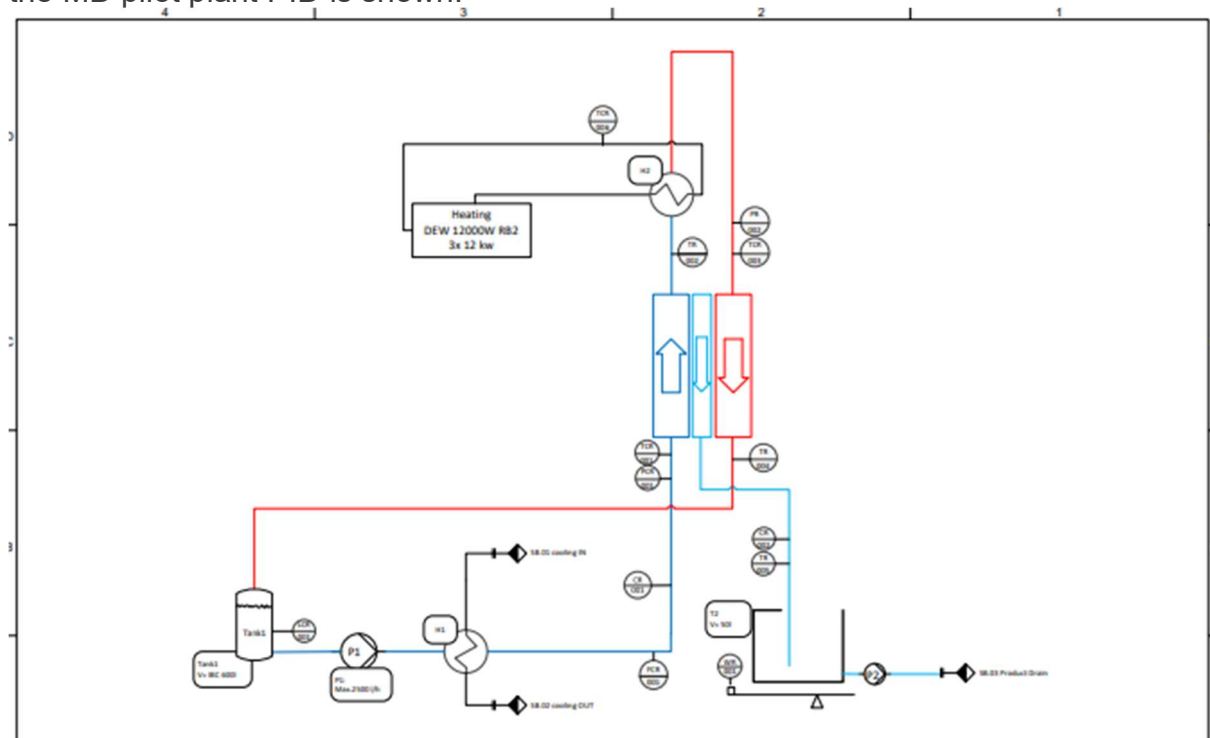

Figure 6. Membrane distillation pilot plant PID scheme.

Treatment capacities for the different processes are the following:

Table 6. CS1 pilot plant treatment capacities.

Process	Treatment capacity
Cartridge filter (pre-treatment)	12 m ³ /day



Process	Treatment capacity
Ultrafiltration	12 m ³ /day
Reverse Osmosis	12 m ³ /day
Membrane Distillation	1 m ³ /day
Zeolite adsorption	1 m ³ /day

2.1.3. Start-up operation

The pilot plant was containerised in a 40 feet maritime container (12.2 m x 2.4 m x 2.9 m), and it was commissioned at AITASA facilities in September 2022. Once the container was located, AITASA completed the water inlet and outlet connections.



(a) External view



(b) Storage tanks



(c) Ultrafiltration process



(d) Reverse osmosis and zeolites column

Figure 5. CS1 pilot plant installed in AITASA facilities.

At first, simple hydraulic tests were done to verify the flow and the functioning of all the equipment. Furthermore, internet connection is available, allowing remote control of ultrafiltration and reverse osmosis processes.

Initially, several actions were driven for the ultrafiltration and reverse osmosis unit's start-up in November 2022: check position pilot container, check hydraulic connections for feed / permeate/waste streams and tighten them and assure not leaks, clean pre-



filters, check electrical connections, control system, sensor signals and internet, fill raw water tank with tap water and chemical storage tanks with chemicals, etc.

Adsorption column is not automatized but it is ready to work. On the other hand, membrane distillation pilot plant start-up is expected to be conducted in the next months.

Pilot plant is in operation since November 2022, and for this reason, experimental results were not available to be included in this Deliverable. Instead, laboratory scale results are presented, on which the design of the pilot plant was based.

2.1.4. Results from laboratory tests and discussion

Initial tests at laboratory scale were conducted during 2021. Although the pilot plant will treat the outlet of the iWWT (pre-treated industrial wastewater), in 2021 this plant was under construction, and for this reason, laboratory tests were carried out with real water from Tarragona industrial complex discharge system, not the outlet stream of the iWWTP. For this reason, it is important to remark that laboratory results were obtained with worst water quality than it will be really treated in the pilot plant.

A water sampling campaign was developed in 2021 in different points of the industrial complex discharge system to estimate the analytical characteristics of the iWWTP inlet.

To simulate this water quality stream (iWWTP outlet), real water from the petrochemical complex discharge system was pre-treated with UF to simulate global iWWTP processes. AITASA sent to Eurecat different water batches to carry out the trials, but high analytical variability in the water composition to be treated was detected, as it was checked during the initial water sampling campaign (TSS=35-239 mg/L, COD=157-405 mg/L, conductivity=5-28,2 mS/cm).

The initial laboratory experimental design was the following objectives:

- Ultrafiltration: assess if a pre-treatment is necessary and to select most suitable membrane material and study membrane cut-off pore size.
- Reverse Osmosis: evaluate the performance of brackish and seawater membranes and determine water recovery.
- Membrane Distillation: to evaluate water recovery at different temperatures.
- Zeolite: to determine ammonium adsorption capacity on zeolites and evaluate zeolites regeneration

These results at bench scale were considered for the later design of the pilot plant. According to these preliminary results, it can be concluded that a 94% water recovery could be achieved with this technology train of UF, reverse osmosis and membrane distillation.

2.1.4.1. Ultrafiltration tests results at laboratory scale

Ultrafiltration technology was assessed as pre-treatment process due to the high suspended solids concentration in the inlet raw water.

Experimental plan was designed to assess the following objectives:



- **UF pre-treatment: solids removal**

Due to the high suspended solids concentration, water was initially filtered with different mesh size sieves: 800, 200 and 100 μm .



Figure 6. Sieves used to filter real water from industrial complex discharge network.

As it was expected, the lower mesh size gave the better results.

- **Membrane material selection: ceramic vs polymeric**

Two different tubular membranes were tested: tubular ceramic membrane, Likuid 0.1micron (1000kDa) and tubular polyester (PES) membrane, CUT (150kDa). All the experiments were carried out a $P=1$ bar and $T=25^{\circ}\text{C}$.



Figure 7. Ultrafiltration experimental set-up. Left: ceramic membrane (1000 kDa), right: polymeric membrane (150 kDa).

Initially, permeability was assessed with the ceramic membrane. For these tests, 25 L water were passed until 80% recovery. The experiment was done twice, without any cleaning between batches.

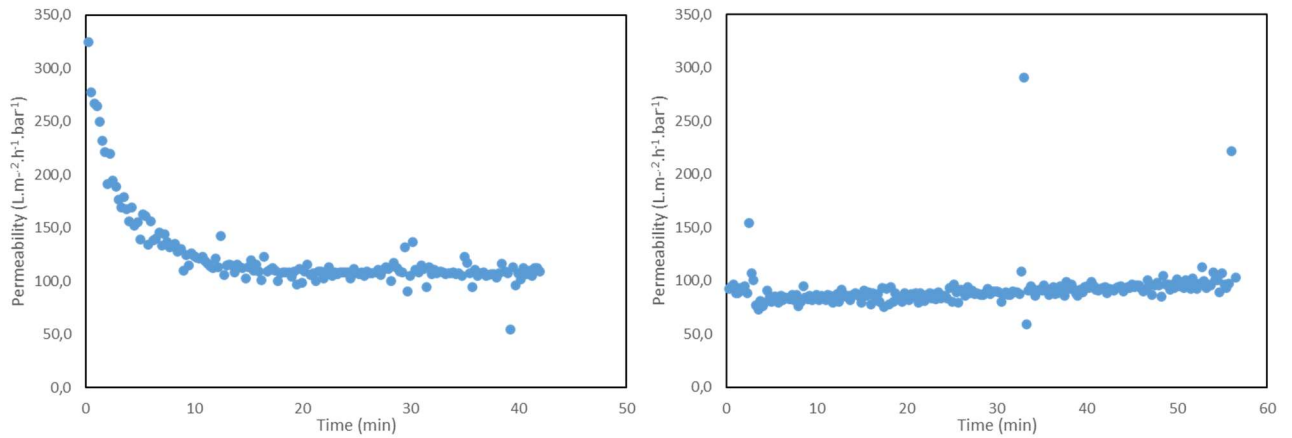

Figure 8. UF permeability at 80% recovery (feed= 25 L) and ceramic membrane. Left: first batch, right: second batch.

It can be observed that the permeability is stable overtime, around 100 L/m²hbar. Feed, permeate and concentrate were analysed. In Table 7 can be checked that permeate turbidity is lower than 1 NTU, and for this reason, UF permeate is suitable to be treated with RO.

Table 7. Feed, permeate and concentrate turbidity and COD values (1000 kDa ceramic membrane and 80% recovery).

Sample	Feed		Permeate		Concentrate	
	Turbidity, NTU	COD, mg/L	Turbidity, NTU	COD, mg/L	Turbidity, NTU	COD, mg/L
Batch 1	2.8	<100	0.51	<100	171	366
Batch 2	10	<100	0.37	<100	0.45	387
Batch 3	32	<100	0.70	<100	184	278

Then, trials were repeated with ceramic and polymeric membrane, both with 90% recovery.

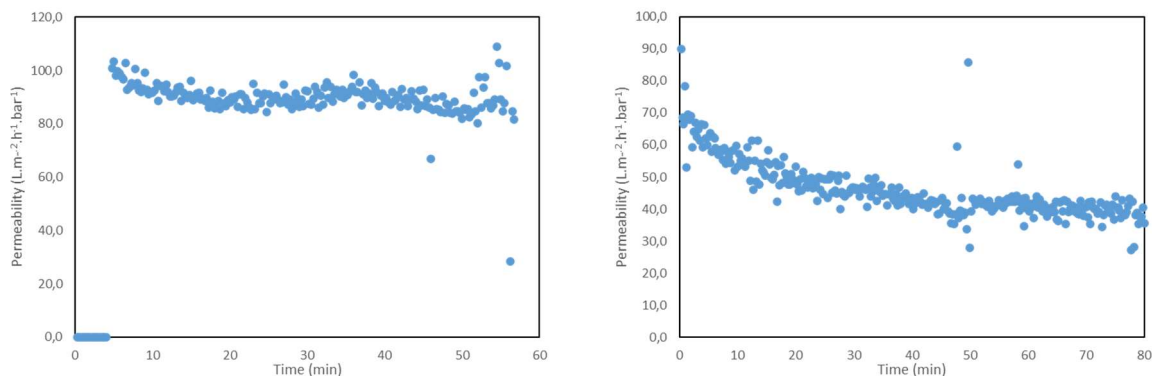

Figure 9. UF permeability at 90% recovery (feed= 25 L). Left: 1000 kDa ceramic membrane, right: 150 kDa polymeric membrane.





In the following table, flux and permeability for both membranes are listed.

Table 8. UF tests results with two different tubular membranes at 90% recovery.

UF membrane	Flux, LMH	Permeability, LMH/bar
Tubular ceramic, Likuid 1000 kDa	90-100	90-100
Tubular PES, CUT 150 kDa	40-60	40-60

As in previous test, feed, permeate and concentrate were analysed.

Table 9. Feed, permeate and concentrate analysis at 90% recovery.

Membrane	Sample	pH	Turbidity, NTU	TSS, g/L	TOC, mg/L	NH ₄ , mg/L	Ca, mg/L	Mg, mg/L	K, mg/L	Na, mg/L
Likuid	Inlet	7.3	165	15.2	48	<5	227	57	42	5370
	Permeate	7.9	2	13.3	38	<5	212	53	38	4860
	Concentrate	8.2	700	14.7	46	<5	202	51	39	4870
CUT	Inlet	7.2	138	14.6	37	<5	199	56	37	5420
	Permeate	8.2	0.39	13.2	27	<5	184	52	34	4830
	Concentrate	8.5	520	14.6	38	<5	182	51	35	4900

Better results in terms of permeate quality were obtained with polymeric CUT membrane, that has a lower MWCO than ceramic Likuid membrane. To determine if the better permeate quality was obtained because of the membrane material or the cut-off pore size, complementary tests were assessed.

- **Study of cut-off pore size**

For this study, two different ceramic membranes were evaluated: tubular ceramic membrane, Likuid 0.1 μm (1000kDa) and tubular ceramic membrane, Likuid 0.01 μm (100kDa).

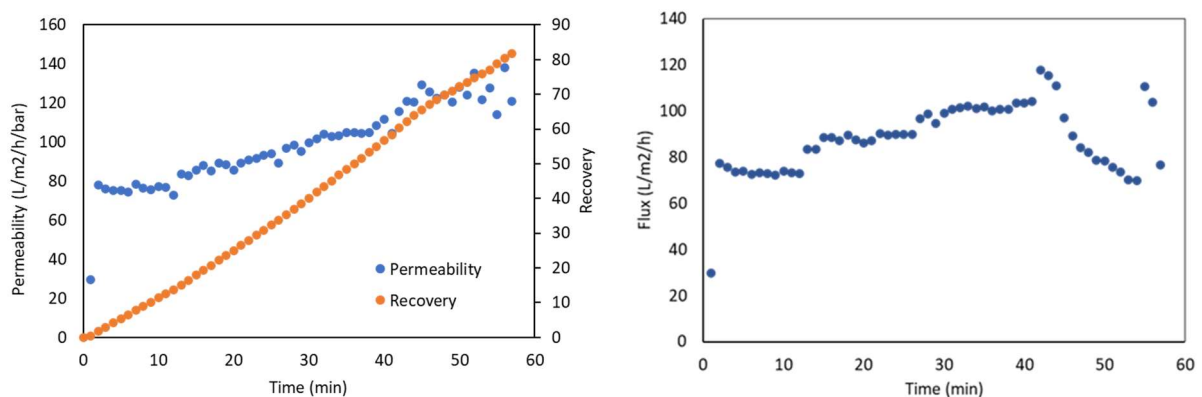

Figure 10. UF permeability, recovery and flux for ceramic membrane Likuid 100 kDa.

Feed, permeate and concentrate were analysed, and, as it was expected, smaller MWCO allows to reach better permeate quality as it can be seen in Table 10.



Table 10. Feed, permeate and concentrate analysis at 90% recovery with Likuid 100 kDa membrane.

Sample	pH	Turbidity, NTU	TSS, g/L	Oil and grease, mg/L	COD, mg/L	NH4, mg/L	Ca, mg/L	Mg, mg/L	K, mg/L	Na, mg/L	Cl, mg/L	NO3, mg/L	SO4, mg/L
Inlet	8	93	14	370	877	8	190	64	31	5030	4510	30	1489
Permeate	8.1	0.7	13	59	250	5	181	61	31	4580	5410	10	1780
Concentrate	8	420	13	1247	250	14	169	57	30	4570	5460	0.5	1774

2.1.4.2. Reverse Osmosis tests results at laboratory scale

Reverse osmosis experiments were carried out with permeate from previous UF tests using the experimental set-up shown in Figure 11.



Figure 11. Reverse Osmosis laboratory experimental set-up.

Experimental plan was designed to assess the following objectives:

- **Membrane selection: brackish versus seawater**

Two different membrane coupons were tested to assess seawater and brackish membrane performances and select the best membrane:

- Seawater membrane: Toray flat Sheet Membrane UTC-82V, polyamide -TFC, RO
- Industrial/brackish water membrane: SUEZ Flat Sheet membrane, SE, polyamide-TFC, RO

Trials were conducted with feed water with conductivity 19.1 mS/cm (UF Likuid ceramic 100 kDa permeate), 40% recovery and at room temperature.

Table 11. Selection of reverse osmosis membrane: brackish vs seawater.

RO Membrane	P, bar	Flux, LMH	Permeability, LMH/bar	Permeate conductivity, μ S/cm
Toray flat Sheet Membrane UTC-82V, PA, RO	40	40-45	>1	209



RO Membrane			P, bar	Flux, LMH	Permeability, LMH/bar	Permeate conductivity, $\mu\text{S/cm}$
SUEZ membrane, RO	Flat SE, PA-TFC,	Sheet	40	30-40	<1	1095

According to the results of Table 11, Toray flat sheet membrane shows better reverse osmosis performance in terms of flux, permeability and permeate quality although permeate obtained with both membranes accomplished with conductivity limit established in Table 5 to reuse reclaimed water as cooling water (< 2000 $\mu\text{S/cm}$).

- **Study of water recovery**

Once it was proven that the seawater membrane gave better results in terms of flux, permeability and permeate quality, complementary tests were conducted to study the membrane performance with higher water recoveries.

According to the tests, flat sheet membrane, Toray flat Sheet Membrane UTC-82V, PA, RO has almost 80% water recovery.

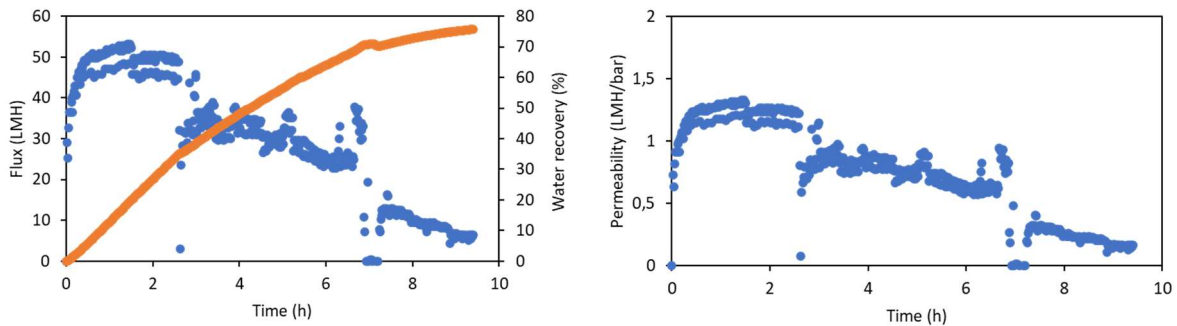

Figure 12. Reverse Osmosis tests with Toray flat sheet membrane at P=40 bar.

High flux during the first hours of operation. After 3 hours, decreases in the range 40-30 LMH. After 7 hours it drops to values between 15 LMH and 5 LMH due to possible scaling. Preliminary results suggest CaCO_3 is precipitating, although scaling simulations suggest CaSO_4 is precipitating after 75% and 80% recovery. A permeate sample was analyzed and its quality and rejection are presented in Table 12.

Table 12. Permeate quality with Toray flat sheet at 40 bar and 75% recovery.

Sample	Conductivity, mS/cm	NH ₄ , mg/L	Ca, mg/L	Mg, mg/L	K, mg/L	Na, mg/L	Br, mg/L	Cl, mg/L	PO ₄ , mg/L	NO ₂ , mg/L	NO ₃ , mg/L	SO ₄ , mg/L
Permeate 70% recovery	1.29	3	2.5	1.4	1.7	253	<0.2	348	<0.2	<0.20	1.33	36
Rejection	0.9	0.3	1	1	0.9	0.9		0.9			0.6	1

According to these results, it can be concluded that reverse osmosis in these conditions wouldn't fulfil with the required reclaimed water limits in terms of conductivity and ammonium to be reused as cooling water.



2.1.4.3. Membrane Distillation tests results at laboratory scale

Tests carried out with the concentrate of the RO previous tests. Membrane distillation operation can work with different configurations, as it can be seen in Figure 13. In this case, Air-Gap Membrane Distillation equipment was used to conduct the laboratory tests.

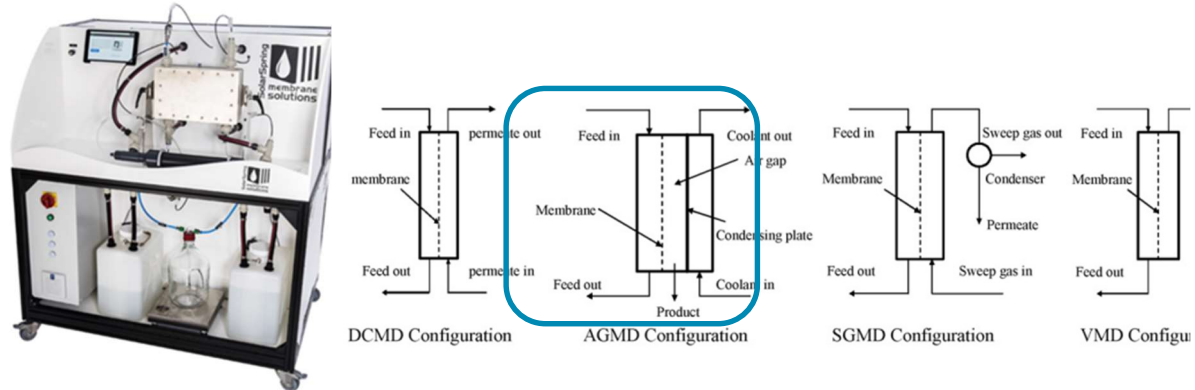

Figure 13. Membrane distillation laboratory experimental set-up.

The installed membrane is Ultra High Molecular Weight Polyethylene one, with 110 μm thickness and 0.2 μm of pore size.

Experimental plan was designed to assess the following objectives the effect of $\Delta T=70$ and 60°C on distillate flux and water recovery

Different temperature ranges were evaluated, keeping $T_{\text{cold}}=15^\circ\text{C}$ and $T_{\text{hot}}=85^\circ\text{C}$ ($\Delta T=70^\circ\text{C}$), $T_{\text{hot}}=75^\circ\text{C}$ ($\Delta T=60^\circ\text{C}$), $T_{\text{hot}}=65^\circ\text{C}$ ($\Delta T=50^\circ\text{C}$).

Table 13. Membrane distillation experimental results.

$T_{\text{cold}}, ^\circ\text{C}$	$T_{\text{hot}}, ^\circ\text{C}$	$\Delta T, ^\circ\text{C}$	Flux, LMH	Water recovery, %
15	75	60	16	80
15	85	70	30	80

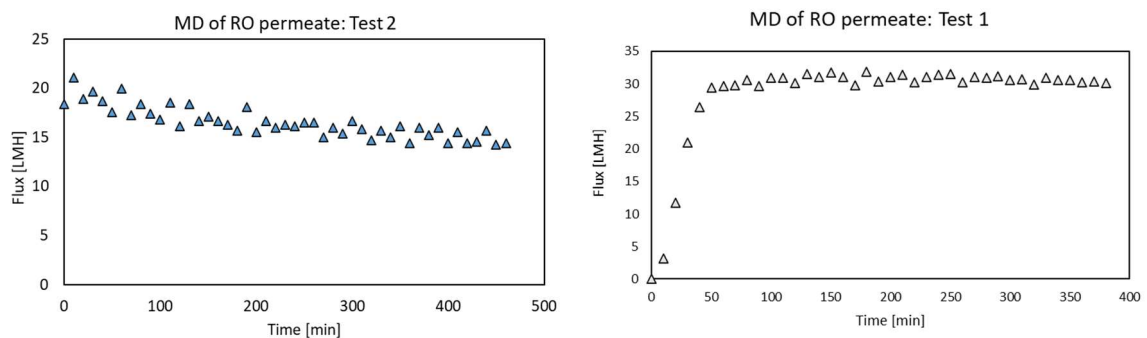

Figure 14. Membrane distillation flux tests: $\Delta T=60^\circ\text{C}$ (left), and $\Delta T=70^\circ\text{C}$ (right).

As it can be checked, higher permeate flux is achieved with $\Delta T=70^\circ\text{C}$. For these conditions, extra tests were conducted to evaluate MD performance using a feed solution of NaCl 35 g/L.

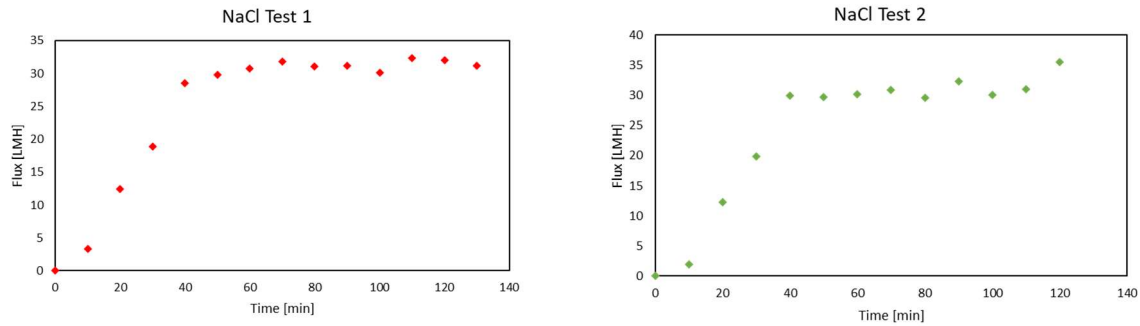

Figure 15. Membrane distillation flux tests: $\Delta T=70^{\circ}\text{C}$ and 35 g NaCl/L feed solution.

As it can be seen in Figure 15, flux remains around 30 LMH.

According to the results obtained for the different technologies recoveries (70% UF+RO and 80% MD), it can be concluded that 94% of reclaimed water can be achieved with this technology train. However, these water recoveries results have been obtained at laboratory scale and they should be checked at pilot plant scale, paying special attention to the water quality that is obtained.

2.1.4.4. Ammonium adsorption on zeolites tests results at laboratory scale

Tests were carried out with permeate from RO previous tests. This RO permeate was doped with ammonium to obtain $\sim 35 \text{ mg NH}_4/\text{L}$ at the inlet (ammonium concentration at the inlet of the RO process in WRP).

Experimental plan was designed to assess the following objectives:

- **Commercial zeolite selection**

Three different commercial zeolites were tested: Zeolite 4 A(IQE), Zeolite 13X (IQE), Zeolite ZN Aqua (Zeocat). 3-hours batch tests were initially conducted to determine the zeolite with the highest ammonium adsorption capacity. Tests were conducted with synthetic water solution with 35 mg/L ammonium (concentration at the inlet of the reverse osmosis process in the water reclamation plant).

Table 14. Ammonium adsorption on zeolites batch tests results.

Zeolite		Outlet NH_4 , mg/L	Adsorption capacity, mg NH_4^+/g zeolite
Type	Granulometry, mm		
Zeolite 4 A (IQE)	0,003-0,005	19,7	0,31
Zeolite 13X (IQE)	0,002-0,006	7,1	0,56
ZN Aqua (Zeocat)	0,5-1	3,5	0,63

According to the batch tests results, zeolite ZN Aqua (clinoptilolite, 82-86%) 0,5-1 mm shows the highest ammonium adsorption capacity, although these values are substantially lower than in literature 0.9-17.7 mg NH_4/g zeolite (Guida et al., 2021).



- **Zeolite ammonium adsorption capacity (break-through curves)**

In Figure 16 the experimental set-up is shown. The column is 10 cm height and 1 cm diameter and outlet samples were taken automatically.

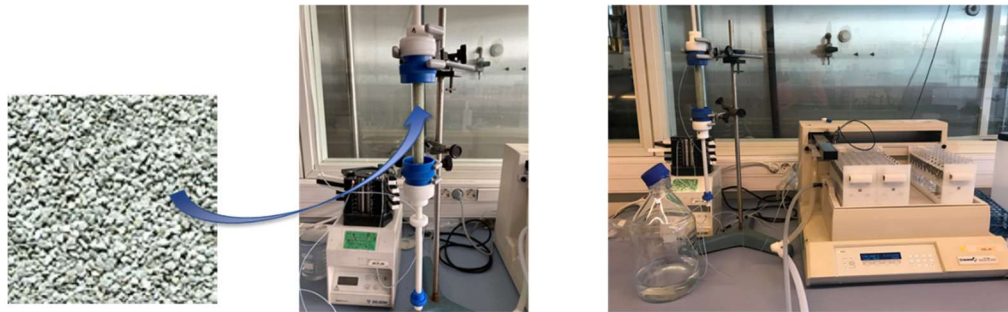

Figure 16. Zeolite adsorption column experimental set-up.

These tests were carried out with RO permeate obtained in previous tests and doped with ammonium (35 mg/L) in downflow operation. Break-through curves were conducted with Zeocat ZN Aqua at three different water bed contact times: 1, 10 and 15 min. Breakthrough time was calculated when NH_4 at the outlet was 0,8 mg NH_4/L (reclaimed water quality requirement by AITASA). New zeolite was used in each experiment.

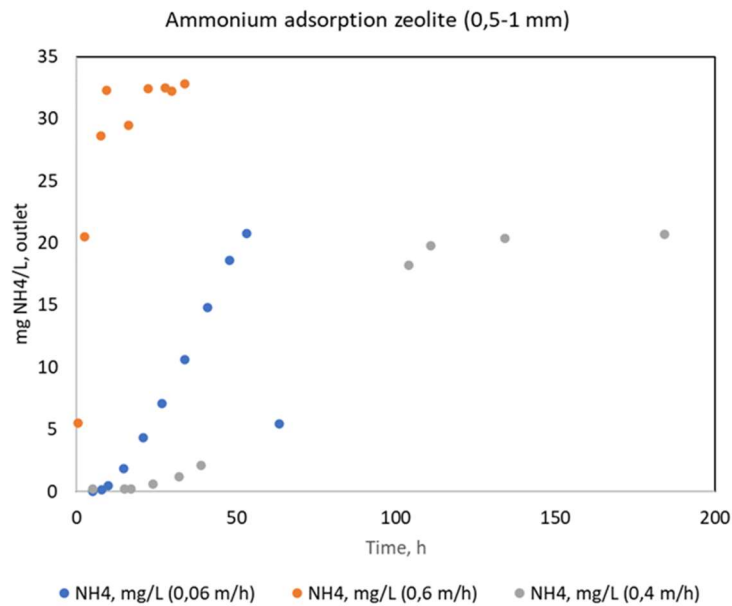

Figure 17. ZN Aqua ammonium break-through curves at different contact times.

Higher ammonium capacity was obtained at the higher bed contact time (15 min): 2,9 mg NH_4/g zeolite, although no big difference is observed at 10 min: 2,8 mg NH_4/g zeolite.



Table 15. Ammonium adsorption capacity obtained with breakthrough curves.

Test	Initial conc., mg/L	Column diameter, m	Column height, m	Zeolite mass, g	Water flow rate, mL/min	Water linear velocity, m/h	Hydraulic time, min	Breakthrough time, h	Adsorption capacity, mg NH ₄ /g zeolite
1	41	0.01	0.1	7.74	0.78	0.6	10.1	11.1	2.8
2	36.7	0.01	0.1	7.68	7.86	6	1	0.07	0.2
3	28	0.01	0.1	7.68	0.5	0.38	15.7	28	2.9

• **Regeneration cycle**

Ammonium adsorption capacity was evaluated after zeolite regeneration with NaCl 10%. After zeolite regeneration, a big increase in ammonium adsorption capacity was observed: 14, 8 mg NH₄/g zeolite.

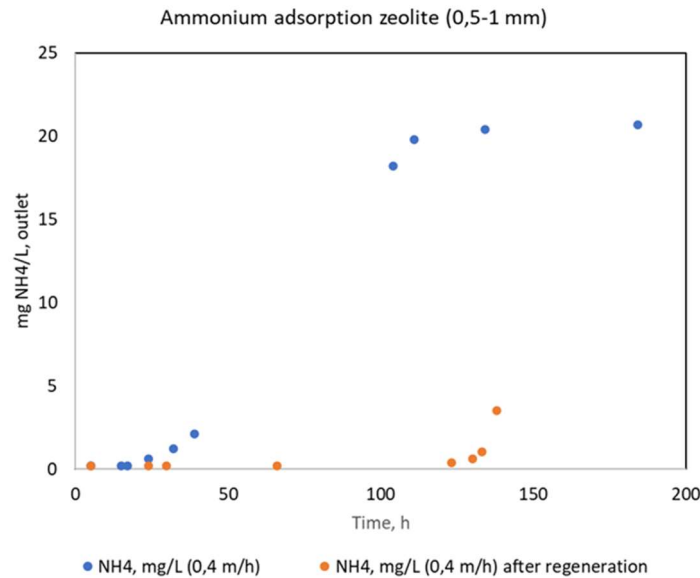

Figure 18. Ammonium adsorption after regeneration.

After regeneration, a breakthrough curve was conducted, calculating the adsorption capacity of the zeolite. It can be checked that this parameter significantly increases after regeneration step.

Table 16. Ammonium adsorption capacity obtained with breakthrough curves.

Experimento	Column diameter, m	Column height, m	Zeolite weight, g	Water flow rate, mL/min	Water linear velocity, m/h	Hydraulic time, min	Break-through time, h	Initial concentration, mg NH ₄ /L	Adsorption capacity, mg NH ₄ /g zeolita
1-adsorption	0,01	0,1	7,74	0,78	0,60	10,1	11,1	41	2,8
2-adsorption-	0,01	0,1	7,68	7,86	6,00	1,0	0,07	36,7	0,2
3-adsorption	0,01	0,1	7,68	0,5	0,38	15,7	26,7	28	2,9
4-regeneration	0,01	0,1	7,68	1	0,76	7,9			0,0
5-adsorption	0,01	0,1	7,68	0,5	0,38	15,7	131,3	28,76	14,8





2.1.5. Case study main conclusions

In CS1 a pilot plant was design and built, implementing four different water treatment technologies based mainly on membranes and adsorption processes. The pilot plant was design based on preliminary tests conducted at laboratory scale with real water. Information obtained with this initial phase was considered for the pilot plant design.

Pilot plant was designed and built by a main supplier, although the membrane distillation module was designed and built by a second supplier. Working with two different suppliers translated into more difficulties in terms logistics and start-up coordination. Furthermore, both suppliers had great delays in presenting the commercial offers and, furthermore, delivery time for several parts of the modules, specially, electrical, and electronic equipment and devices.

Finally, all the equipment was assembled into a 40 feet maritime container to facilitate transport and delivery. It is needed to remark that civil works were done by AITASA to prepare pilot plant location at its facilities.

Pilot plant was delivered in September 2022, and then, some works to adapt hydraulic and electrical connections were needed at the site. The start-up operation and technical staff training was carried out in November 2022, but first results showed problems with high conductivity at the outlet of the reverse osmosis and for this reason, initial brackish membrane in the reverse osmosis unit was changed and currently, seawater membranes are installed.

Pilot plant in is operation since November 2022 and initial tests are being conducted with ultrafiltration and reverse osmosis units in order to assess the water quality that can be obtain and optimize the operation parameters. Membrane distillation and adsorption tests will be conducted in the next months.

2.2. CS2 Nieuw Prinsenland (Netherlands)

2.2.1. Brief description of the case study and objectives

The Nieuw-Prinsenland area is a modern agro-and food cluster aiming at maximum symbiosis among industries (Sugar Factory Suikerunie, high-tech greenhouses, food processing, and bio-energy) with regards to water, energy, and waste. By organizing different industrial activities around the sugar factory, maximized reuse is attained between the sugar factory and the industries and among the industries themselves.





Figure 19. Energetic interaction between the agro- and food cluster in Nieuw-Prinsenland area.

The symbiosis that is to be reinforced by ULTIMATE technologies is the already existing one between the greenhouse area (Coöperatieve Vereniging Glastuinbouw Nieuw Prinsenland u.a.) and the sugar factory (Suikerunie). The horticulture sector in the Netherlands had to reach 95%+ elimination of crop protection agents from discharged wastewater by 2021. Furthermore, it has to reach zero emission in nitrogen and phosphorus by 2027. This means substantial investment in water treatment will be required. Simultaneously, there is a need for supplementation of the primary water source (rainwater) during the summer months. Further optimisation of re-use and recovery, going beyond the existing symbiosis, is therefore required.

For the development of the water and resource recovery solutions, this case study focuses on piloting and demonstration activities at De Vlot. Coöperatieve Tuinbouw Water Zuivering de Vlot is a wastewater treatment facility (Figure 20) located at 's-Gravenzande treating 160 hectares (60 companies) of drainwater from greenhouses mainly growing ornamental crops. This facility has ambitions to reach zero liquid discharge and provide symbiotic internal and potentially external reuse of water and nutrients from greenhouse drainwater (approx. 10% discharge). The current system to treat and reuse drainwater from 60 greenhouses (160 ha) is laid out maximum capacity of 60 m³/h, with 3 parallel treatment lines. Current discharge is at a maximum of 40 m³/h, with the third line only required in case of maintenance. The current treatment is designed for compliance with the emission guidelines concerning crop protection agents. The existing treatment plant consists of:

- Prefiltration by vibrating and rotating filters: suspended solids removal
- Coagulation in sedimentation buffers: phosphorus removal
- Sand filtration with glycerol dosage: nitrogen removal
- Activated carbon: crop protection agent removal



Figure 20. Treatment plant De Vlot.

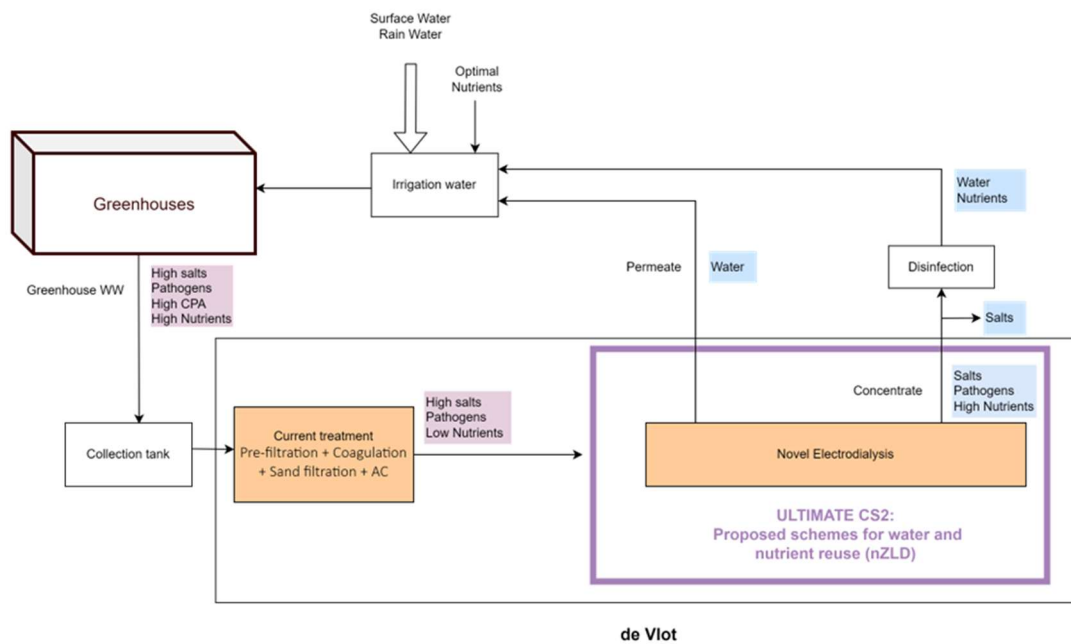

Figure 21. The proposed technological solutions from ULTIMATE in the water system at De Vlot (ULTIMATE addition indicated in purple).

This case study aims to demonstrate advanced wastewater treatment technologies for reliable treatment and reuse of greenhouse drain water and nutrients. The objective is to divert drain water from being discharged into the sewer and reusing water and nutrients back in the greenhouses. The proposed solution is shown in this context in Figure 21.



2.2.2. Technological solution in ULTIMATE project: pilot plant description

To make the effluent of the treatment plant at De Vlot, which is representative for greenhouse horticulture wastewater, suitable for reuse as irrigation water, the following conditions need to be achieved for the recycled water:

- 1) free of plant pathogens
- 2) free of plant protection agent and
- 3) the sodium concentration is strictly controlled.

In addition, in ULTIMATE the objective is to retain valuable nutrients still present in the water and recycle these together with the water without separation.

As removal of plant protection agents is already established (i.e. realised by the carbon filters already in place) and removal of pathogens can be achieved with existing technological solutions, the work in Case Study 2 focuses on the selective removal of unwanted inorganic ions, in particular sodium, from the recycled water stream. To achieve this, electrodialysis has been identified as the most promising candidate technology.

Electrodialysis (ED) is an electrochemical separation process that (selectively) transports ions through electrostatically charged ion-exchange membranes (IEMs) driven by an electrical potential difference (applied electric field). ED is a well-established technology with applications in treating brackish water, industrial wastewater, municipal wastewater, table salt production, heavy metals removal, and acid and bases production.

An ED installation contains one or more ED stacks. An ED stack consists of alternating anion exchange membranes (AEM) and cation exchange membranes (CEM) arranged in series between an anode and a cathode. An electric potential difference is set between the anode and cathode. When an ionic solution, such as wastewater, flows through the cells the positively charged cations are being attracted by the cathode and negatively charged anions by the anode. The positively charged cations pass through the negatively charged CEM but are retained by the AEM. Likewise, the negatively charged anions pass through the AEM and are retained by the CEM. This results in a concentration of ions in alternating compartments (concentrate) and simultaneous depletion of ions in the others (diluate). Selectivity in ED can be further enhanced by employing monovalent selective membranes (MVMs) – anionic (MVAs) and Cationic (MVCs) – to separate monovalent and multivalent ions.

To validate ED as a technology for treatment of greenhouse wastewater a pilot is constructed according to the PID in Figure 22.



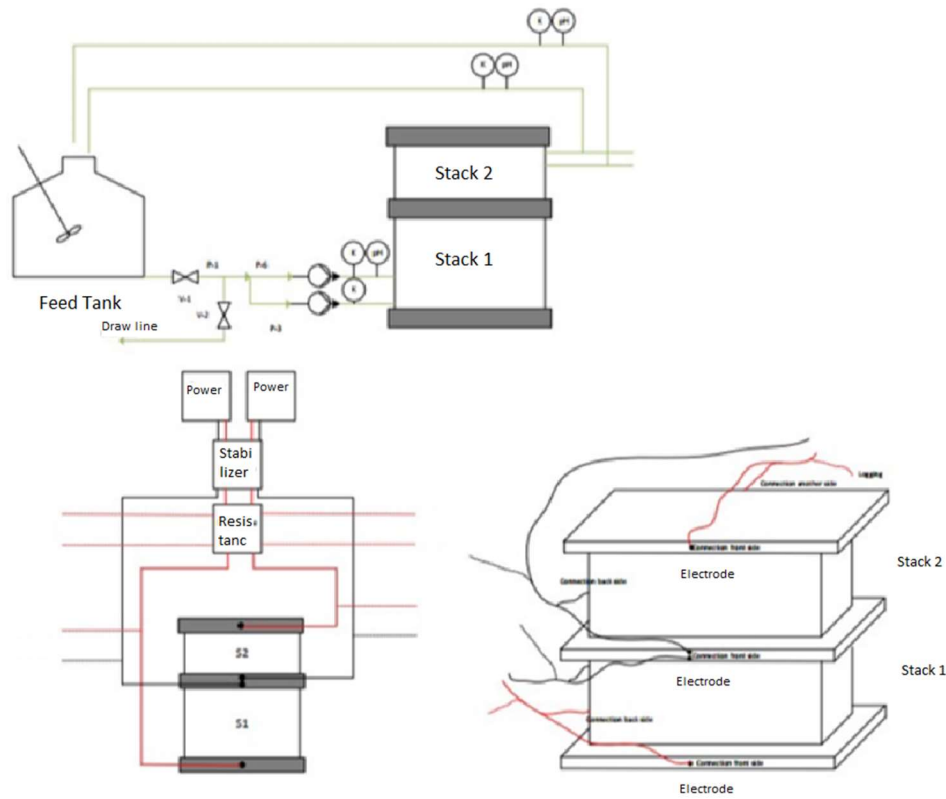

Figure 22. PID of the ED stack and pilot installation.

2.2.3. Start-up operation

The Capacitive ED pilot was set-up and the tested/calibrated by performing control experiments. In CED technology the electrodes are carbon based and this reduces the need for electrode rinsing solution needed in ED.

First, synthetic greenhouse wastewater was prepared (KH_2PO_4 : 57.7 mg/l, NaHCO_3 : 497.36 mg/l, $(\text{NH}_4)\text{HCO}_3$: 90.5 mg/l, NaNO_3 : 153.25 mg/l, MgSO_4 : 248.84 mg/l, KNO_3 : 183.42 mg/l, CaCl_2 : 521.69 mg/l, Conductivity: ~ 1.6 mS/cm), and pilot experiments were conducted as a simulation with various operating conditions (Table 17).

Table 17. ED pilot operating conditions.

Flow Rate Diluate (Pump 1) ml/min	Flow Rate Concentrate (Pump 2) ml/min	Water Recovery %
800	1200	60
650	1400	68.3
550	1650	75
450	1800	80
250	2500	90





The pilot plant has a water treatment capacity of 1-4 m³/day, depending on the water recovery ratio.

These experiments were followed by experiments with real water (effluent from de Vlot). The synthetic and real water streams were tested in the Capacitive ED (CED) pilot plant (Figure 23). The CED stack consisted of 4 hydraulic stages, 150 membrane pairs (FujiFilm type 10), active area of electrodes: 400 cm² was operated at 2.4 cm/s and 4.8 cm/s flow velocities and in 1-pass mode. The voltage, current, pressure drop, and conductivity, flow rate, and pH of feed, concentrate, diluate were logged every 5 sec. The specific energy (kWh/m³), the current efficiency of nutrients compared to strong electrolytes (Na and Cl), water recovery (%), concentration factor, and losses (%) were calculated. The quality of the product water was aimed to target the Dutch Greenhouse Water Quality guidelines (Water Quality Class from 1.1 to 3.3).

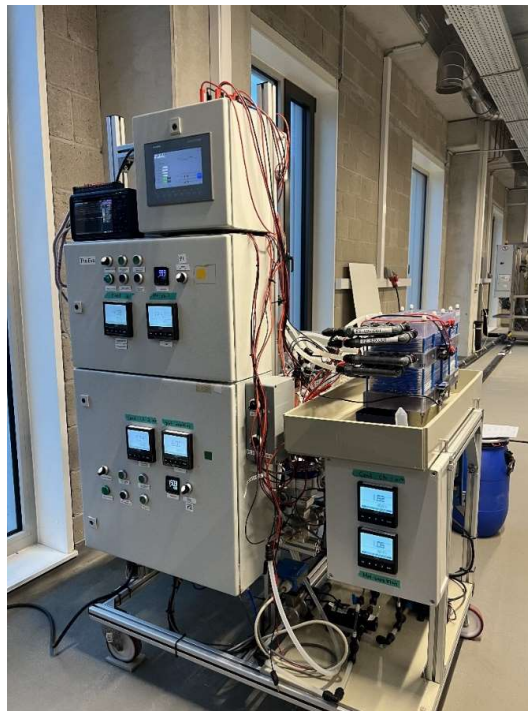

Figure 23. ED pilot installation.

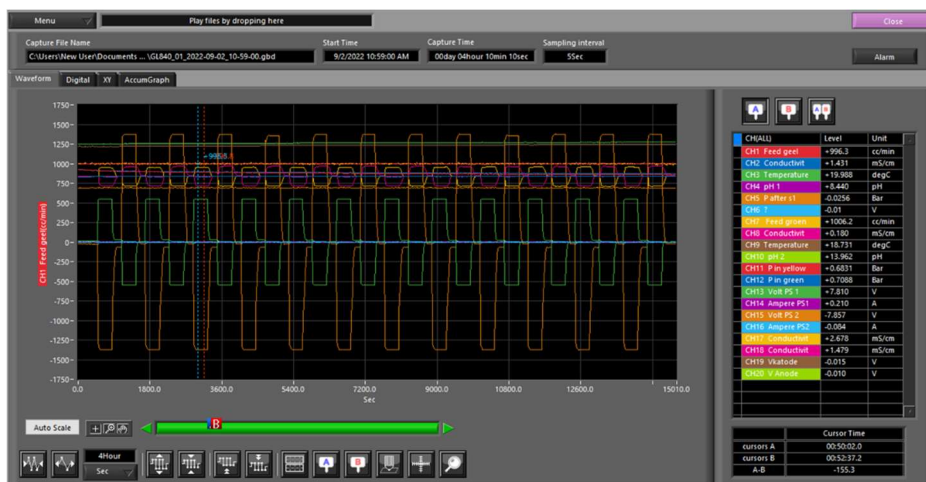

Figure 24. Data logging system in the CED pilot.





2.2.4. Results from pilot plant operation and discussion

Using synthetic wastewater representative of the case study containing salts, the CED setup CED stack was able to achieve recoveries from 60%-90% (Figure 25). At higher voltages (12V), the quality of the recovered water stream diluate reached Class 1.1 to 1.3 (high quality irrigation class, below 0.5 mS/cm, 1 mM Na, and 1 mM Cl). With decreasing voltage (10V to 6V), the quality of the diluate reached Class 2.1 to 3.3 (EC <0.5 mS/cm and EC 1- 0.5 mS/cm, respectively).

The specific energy increased with increasing recovery for a specific voltage for a given recovery. Conversely, the specific energy decreased with increasing recovery for a specific voltage. Although the highest specific energy measured was 0.07 kWh/m³ (i.e., resulting in a diluate of the highest quality-Class 1.1), it is worth remarking that this is the DC energy measured from purely from the voltage applied in the separation process and excludes the stack and does not reflect the energy from pumps (max. pressure drop of 0.45 bar), base load, etc. and ECA.

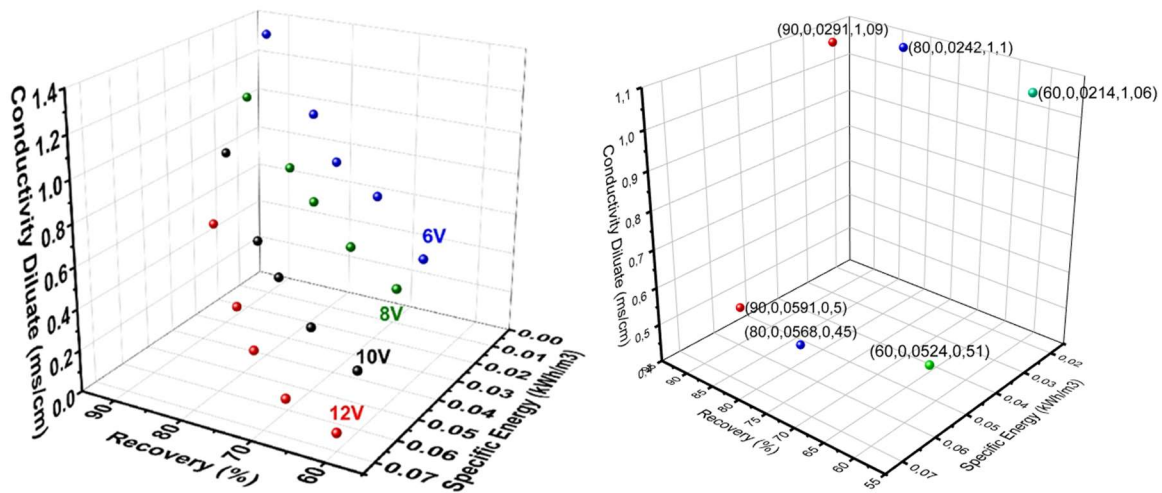

Figure 25. Specific energy consumption (kWh/m³) as a function of recovery (%) and conductivity of the recovered water (mS/cm) for synthetic (left) and real (right) greenhouse wastewater experiments.

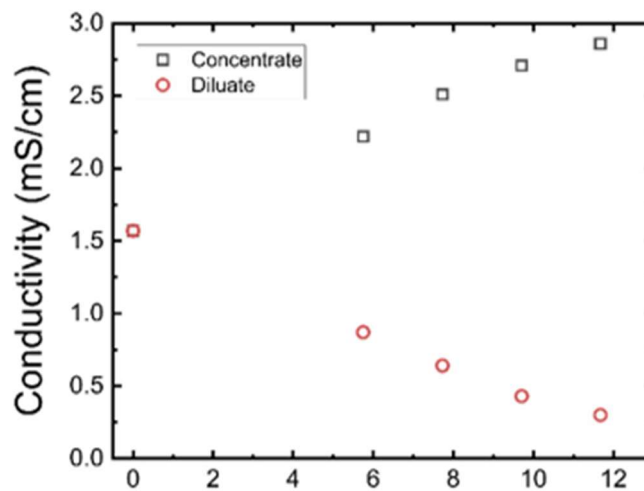

Figure 26. Change in conductivity over different voltages in the diluate and concentrate for the synthetic greenhouse wastewater CED pilot runs.





For the water quality, small mobile ions, i.e., Na, Cl, and K (nutrient), showed the highest transport through the ion-exchange membranes. Initial results show that the lowest current efficiencies were observed for nitrate, and phosphate, thus showing lower concentrations in the concentrated solutions. Although significantly good concentration factors were achieved for the nutrients in general (i.e., concentration factors ranged from 4.2 to 8.9), losses were also observed.

On-going experiments are being conducted to optimize the operating parameters to improve the water quality (water recovery and nutrient concentration) and energy consumption. Additional treatment post the CED pilot will be required (selective membrane or adsorption technologies) for improving the nutrient recovery. Fouling not observed in the CED system as a limitation with initial experiments. More long-term tests needed to validate the influence of fouling.

2.2.5. HT-ATES feasibility – experimental work

In addition to the water and materials components of the activities in Case Study 2, a feasibility study is conducted to verify whether decarbonisation of the heat supply for greenhouses can be supported by high-temperature aquifer thermal energy storage (HT-ATES) in combination with a geothermal well.

Currently, greenhouses in the Netherlands are heated during wintertime by burning natural gas. Geothermal energy can be used as an alternative source of heat for greenhouse heating. However, geothermal systems produce excess heat in summer, while capacity in winter is not enough to meet peak demand. By storing the produced heat in summer and deliver this in winter during peak demand increases utilization of the geothermal heat and reduction of emissions. Hence, the combination of a geothermal system and HT-ATES allows for optimal utilization of the available heat and also cost effectively and carbon free supply of peak demand. Because HT-ATES is not a proven technique yet, it is important to have demonstrations of HT-ATES, to overcome uncertainties in technical, financial, and regulatory fields as well as gain trust with developers to apply the technology.

In this study, the feasibility of HT-ATES for the TRIAS Westland project is assessed, and the site of TRIAS Westland is used to develop and demonstrate a cost-effective method to identify and characterize suitable aquifers for HT-ATES by combining the drilling of a geothermal well with logging and screening of potential HT-ATES aquifers. Hence, the goal of this work was two folded:

1. Identify the (technical, economic, legal, environmental) feasibility of HT-ATES in the TRIAS Westland project.
2. Develop a (combination of) method(s) for logging and screening of possible suitable layers while drilling of a geothermal wells.

The second item, which required piloting a new drilling methodology, has been successfully validated and completed.

2.2.5.1. Methods for screening, while drilling for deeper aquifers

Detailed knowledge on the composition of the subsurface is key to correctly assess HT-ATES feasibility. While drilling a geothermal well, the potential layers for HT-ATES are penetrated, which creates a window of opportunity to screen them to obtain this



detailed insight. Logging/screening these shallow layers while targeting a (much) deeper aquifer, is a cost-effective method to gather valuable information to reduce uncertainty for the application of HT-ATES.

In this study it was demonstrated that data acquisition for shallow layers, during drilling activities for geothermal systems, can cost effectively and successfully be implemented. The obtained data provided great insight in potential layers at reasonable costs. The approach followed in this study can easily be applied in other projects.

The approach consisted of deepening the conductor drilling of the geothermal well, which are usually around 100 m depth in NL, schematically represented in the figure below. Those conductors are generally made by smaller rigs. This had 2 main advantages:

1. The daily rate of such rigs is much lower than for the large rig drilling to several km depth. So, the costs of extra time needed to screen the shallow subsurface is acceptable.
2. Such rigs allow for reverse circulation flush drilling, providing very accurate cutting samples along the borehole depth.

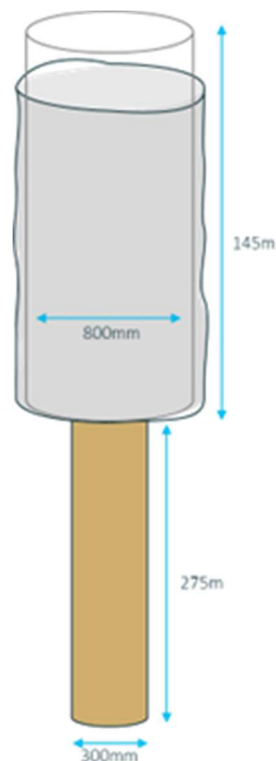

Figure 27. Schematic representation of the deepening drilling as carried out at the TRIAS Westland site.

Below are representations of the methodology applied and the samples obtained of the subsurface screening. During the drilling, the following measurements were also performed:

- SONO/LONO (electrical resistance)
- Gamma Ray and Spectral Gamma Ray



– Single Point Resistance (SPR)

These logging devices measure the average subsurface properties over the device length (1 – 2 m) of the subsurface around the borehole. Gamma Ray (GR) is used to give indication of the clay content of the sediment. High relative GR means high clay content. With SONO (Short Normal electrical resistance measurement, 0.5 m into subsurface) and LONO (Long Normal, 1.5m into subsurface) the electrical resistance of the soil+groundwater is measured. With fresh water, low resistance indicates high clay content and high resistance high sand content. With Single Point Resistance, the electrical resistance between the top and the bottom of the probe is measured. With sudden changes in SPR, sediment changes are indicated. With Electro Magnetic Induction (EM-induction), the bulk electrical conductivity of the subsurface is measured. Finally, also the spectral Gamma Ray (SGR) signal of the subsurface is measured. Like the normal Gamma Ray, high SGR measurements indicate high clay content, however, with SGR the three separate components of the GR signal (40K, 232Th, 238U) are deduced. This could indicate the difference between high GR due to clay/sand and other material like glauconite.

During the drilling, cutting samples are taken each meter and stored in sample buckets. A subsample of the sediment per meter was collected in plastic bottles for lab analysis if needed later. Core sampling is used to get an in-situ sample of the subsurface at a specific depth range. These samples provide insight in subsurface property variability and could be analyzed to determine important hydrogeological and thermal properties. The specific sampling depths were determined before the drilling based on available 'local' GR logging data of old oil drillings. The cores were taken using a coring technique that uses a load to hammer in the coring device (figure below). First, the coring device is dropped inside the borehole when the desired depth is reached. Secondly, the load, attached to the hinge of the drilling rig, is lowered inside the borehole. The hinge is continuously pulled and dropped for many times (e.g. >50) to push in the coring device. The process of hammering can take up to 30 min.

After retrieval of the cores, the fullness of the PVC core is checked and if needed the core is cut to the filled size. As sound as possible, plastic end caps are put on the bottom and top to prevent oxygen mixing with the sediment and groundwater. Subsequently, the top and bottom of the core are filled with paraffin to seal off the sediment from the outside. Subsequently PVC endcaps are put on and taped. Finally, the depth, top/bottom marking, and the name are applied on the core and end-caps using water-proof marker.





Figure 28. Picture of the coring device that was used to obtain the core samples.

Preliminary results of the analysis of the logging and core samples are shown below. Further analysis of the cores is scheduled to be completed in Q4 2022.



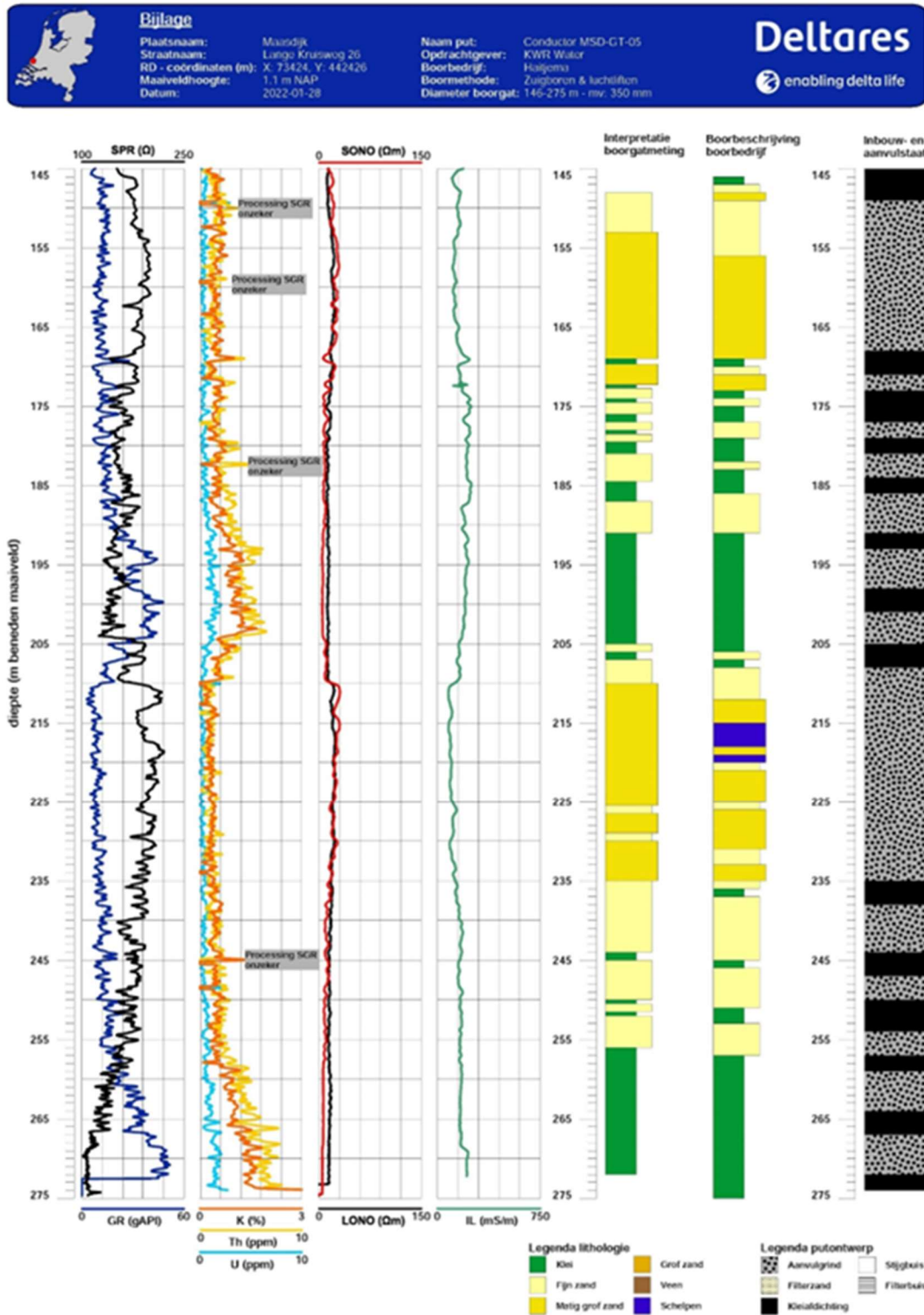

Figure 29. Lithological interpretation and well completion information from 145 to 275 m depth, based on the logging data and cuttings description.





2.2.6. Case study main conclusions

The case study Nieuw Prinsenland consist of two main components: a pilot plant for water and nutrient recovery and a feasibility study on energy storage. The latter is a desktop study, and a pilot plant will not be constructed.

The pilot plant for water and nutrient recovery was realised. The solution uses capacitive electrodialysis as a means of separation and can treat 0.1m³/day. The system has been commissioned and calibrated in the laboratory by performing control experiments and is ready to be moved to the case study site. No major problems were encountered during commissioning and start-up, but updates of the potentiostat that generates the voltages over the membranes, was required to provide a higher capacity. Also, small redesign of the membrane stack was required, as the used material has proven to be too fragile, leading to crack and leakage.

With the synthetic greenhouse wastewater, it was proven that high quality water can be reclaimed, and that the required specific energy is in the range of 0.1kWh/m³, which is lower than for typical membrane based separation technologies such as reverse osmosis on similar water types.

The lowest current efficiencies were observed for nitrate, nitrite, and phosphate, resulting in lower recovery of these nutrients into the concentrated solutions. Although significantly good concentration factors were achieved for the nutrients in general (i.e., concentration factors ranged from 4.2 to 8.9), losses were also observed following the trend: phosphate>nitrate>=nitrite. Improvement of nutrient recovery by further optimisation of the process is required.

The pilot plant was commissioned with a substantial delay, which was caused by Covid-19 restrictions and subsequent delays with delivery of components. Sufficient time, however, remains to complete the field testing required. To mitigate the lost time, laboratory experiments have been continued and will continue for the remained of the project, simulating the operational conditions on smaller scale.

2.3. CS3 Rosignano (Italy)

2.3.1. Brief description of the case study and objectives

The ARETUSA Consortium has been established in 2001 with the aim to associate an urban water utility (ASA Azienda Servizi Ambientali Spa), an industry (Solvay Chimica Italia Spa) and a technology provider (TME Termomeccanica Ecologia Spa) in a public and private partnership (PPP) to optimize water management at regional level.

Thanks to ARETUSA water reclamation facility, Solvay replaces high-quality groundwater with fit-for-purpose treated municipal wastewater for industrial use, while groundwater is more exploited for drinking water production to serve the coastal areas. Up to 3.8 Mio. m³ per year of treated municipal wastewater is already reused by the industrial partner Solvay, freeing up private industrial wells for drinking water use. Currently, the Solvay plant has highly expanded both in terms of production and variety, which further increases the water demand. The plant produces sodium carbonate, sodium bicarbonate (also for pharmaceutical use), calcium chloride, chlorine, hydrochloric acid, chloromethane, plastic materials, peracetic acid and hydrogen peroxide.



The ARETUSA water reclamation facility (Figure 30) was designed to treat the secondary effluent coming from the two municipal Wastewater Treatment Plants (WWTPs) of Cecina and Rosignano by chemical, physical, and biological processes in order to reach the quality requirements of Solvay for industrial reuse.



Figure 30. ARETUSA WRP in Rosignano WWTP Area.

The catchments of Cecina and Rosignano WWTPs are impacted by currently unpredicted and relevant seawater intrusion that increases the chloride concentration in wastewater up to levels higher than acceptable and agreed by the contract in force among the ARETUSA partners. In addition, other parameters (e.g., surfactants, COD, hardness) can irregularly and unpredictably exceed the quality standard required for industrial reuse at Solvay plant.

CS3 aims at extending and optimising the quality and quantity of treated water increasing the technical, economic, and environmental sustainability of industrial reuse, in a local circular economy context. To reach this purpose, the research activities of ULTIMATE project aim at:

1. developing a real-time data driven monitoring and process control system for seawater intrusion and infiltration to overcome salinity peaks in the influent to Aretusa plant;
2. demonstrating the potential to reuse by-products of local industries for water treatment.

Regarding this second objective, mineral by-products and alternative adsorbent materials have been tested at laboratory scale for their application during wastewater treatment. Particularly, hydrochar produced by hydrothermal carbonization (HTC) of sewage sludge has been investigated for replacing granular activated carbon (GAC) in filtration units, while cooked limestone and carbonate by-products provided by Solvay have been tested as coagulants and softening agents to be used during clarification processes. Finally, H_2O_2 produced by Solvay is being tested to upgrade



the UV disinfection unit of ARETUSA plant to an Advanced Oxidation Process for micropollutants removal.

Since the installation of clari-flocculation and UV/AOP pilot systems has been decided by the Grant Agreement amendment No AMD-869318-12 of April 2022, data related to the design and realization of these two pilot systems will be reported in the deliverable D1.5 “New approaches and best practices for closing materials cycles within symbiosis cluster”. In this deliverable are reported data related to the realization and start-up of the adsorption pilot plant, which has been equipped with innovative sensors based on fluorescence and UV absorbance measurements for process control and monitoring.

2.3.2. Technological solution in ULTIMATE project: pilot plant description

The adsorption pilot-system has been realized with the scope to test alternative adsorbent materials to replace GAC during wastewater treatment, and to investigate the use of innovative sensors based on fluorescence and UV absorbance spectroscopy for process control and monitoring. Particularly, UV and fluorescence signals, which are surrogate parameters to evaluate organic matter content in wastewater, are being tested to monitor the breakthrough curve of organic material (in terms of dissolved organic carbon), but also the adsorption process of organic micropollutants (e.g., pharmaceuticals and personal care products).

The adsorption pilot system has been equipped with different on-line sensors for real-time measurements, which include an electromagnetic flow meter (SIEMENS - SITRAN FM MAG 5100W), pressure transmitters (SIEMENS – SITRANS P200), a pH probe (Hach Lange 1200-S sc); a conductivity probe (Hach Lange 3798-S sc), an UV absorbance sensor reading at 254 nm (Hach Lange UVAS sc), and a fluorescence sensor reading at the excitation/emission couple of 325/445 nm (Cyclops-7F Submersible Fluorometer). All sensors are connected by a control unit (Hach Lange - ICS-1000).

The pilot system has four adsorption columns hydraulically connected to be operated in series or in parallel. Considering a design empty bed contact time (EBCT) of 10 min, the big columns can be operated with a flow rate of around 3.5 m³/h, whereas the small columns can treat around 0.5 m³/h of wastewater. Different size of columns was added to have the same conditions (EBCT) with different amount of material available. This was done considering the high loss weight that the activation process, needed for using Hydrochar as adsorbant, could produce. The design parameters of the adsorption columns are reported in Table 18.

Pressure transmitters are installed in line to control the pressure within each column, whereas all the other sensors are placed in a monitoring tank. The PID of the adsorption pilot system is reported in Figure 31, whereas a picture showing all the components of the adsorption pilot plant is shown in Figure 32.

Table 18. Design parameters of the adsorption columns.

Big Columns			Small Columns		
EBCT	10	min	EBCT	10	Min





Big Columns			Small Columns		
Flow rate per each column	3.6	m ³ /h	Flow rate per each column	0.5	m ³ /h
Area	0.5	m ²	Area	0.07	m ²
Radius	0.40	m	Radius	0.15	m
Bed height	1.65	m	Bed height	1.30	m
Surface Load	7.2	m/h	Surface load	7.5	m/h

In the following sections of this paragraph will be described:

- laboratory tests accomplished to evaluate the adsorption properties of hydrochar after different activation procedures considering their replicability at large scale.
- thermal treatment of hydrochar (i.e., slow pyrolysis process) accomplished at pilot scale to produce the alternative filling material for the adsorption columns.
- first results from the on-line monitoring tests performed at pilot-scale.

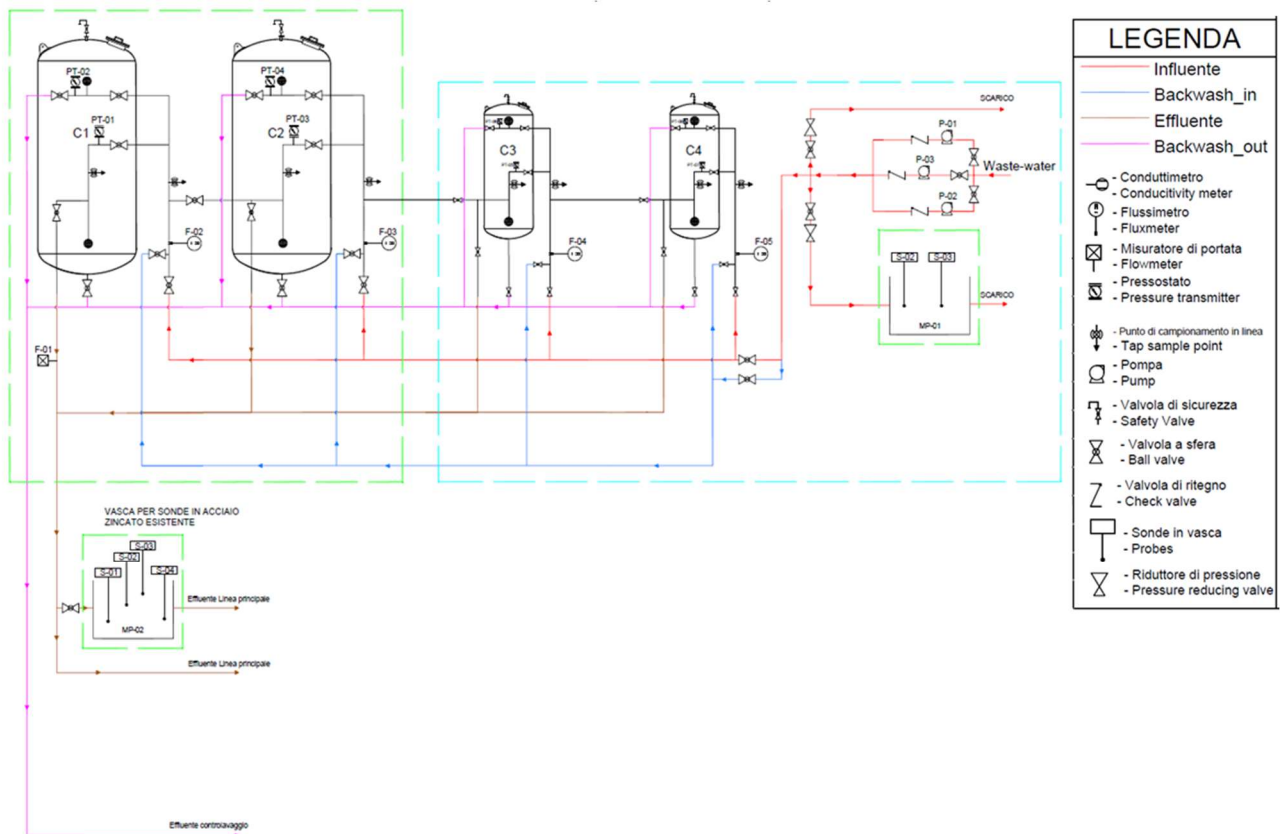

Figure 31. PID of the adsorption pilot plant.



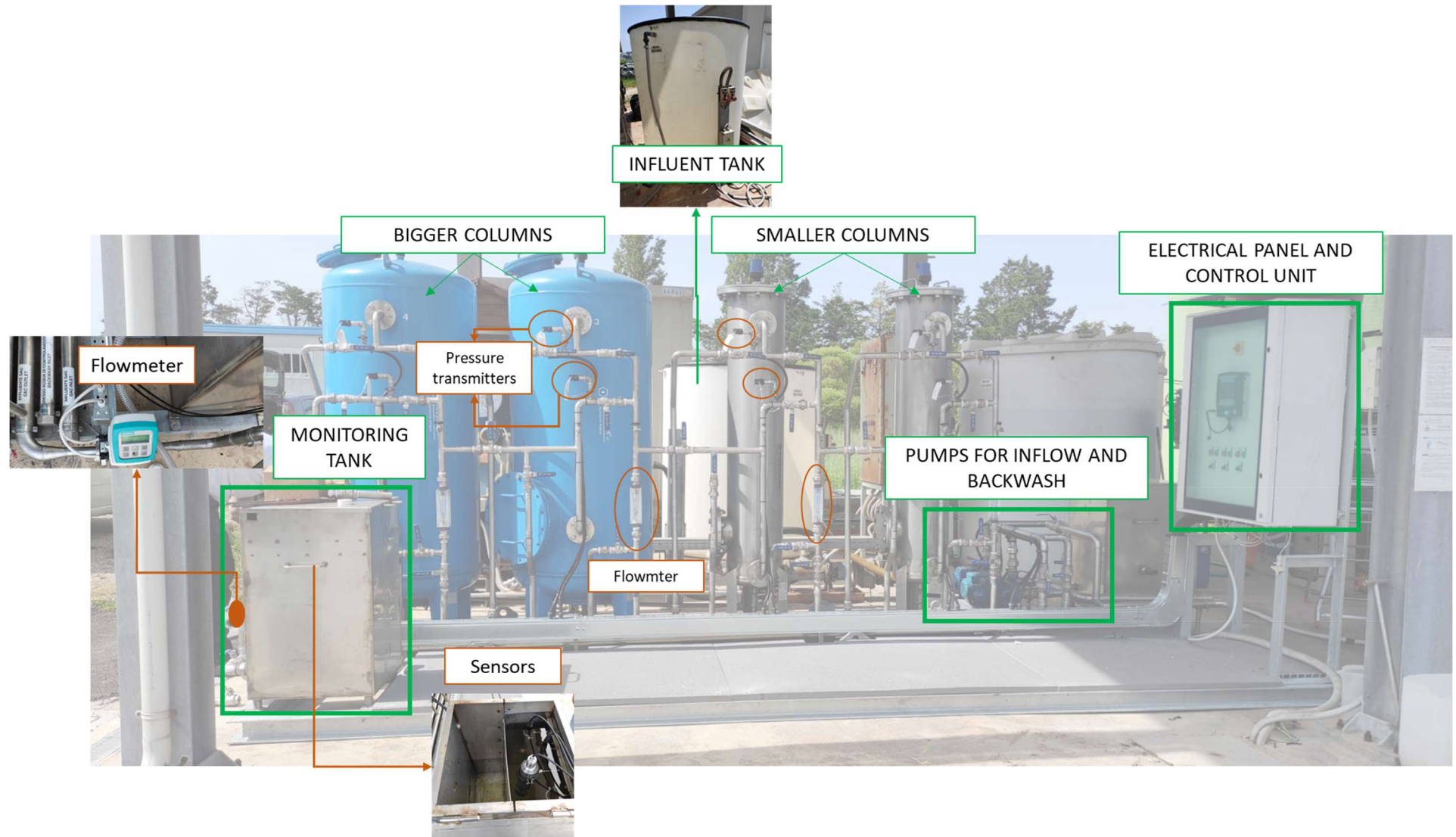

Figure 32. Adsorption pilot plant.





2.3.3. Start-up operation

The start-up operations of the adsorption pilot plant were accomplished in July 2022 at the experimental pilot hall of the Polytechnic University of Marche located at the WWTP of Falconara Marittima (Ancona, Italy).

The start-up operations and the first adsorption tests (still ongoing) have been accomplished using the commercial GAC FILTERCARB CSC5 purchased by CARBONITALIA. Technical characteristics of FILTERCARB CSC5 are reported in Table 19. Further tests are planned using different GAC and the pyrolyzed hydrochar.

Table 19. Standard specifications - CSC5.

STANDARD SPECIFICATIONS - CSC5			
Specifications	Unit	Values	Methods
BET Surface area	m ² /g	500 ± 50	BET N2
Ash content	%	< 10	CEFIC 1986
Bulk density	g/cm ³	0,50-0,55	CEFIC 1986
Humidity	%	< 2	CEFIC 1986
Grain size:			Wet sieving
> 5 mm	%	0,5	
< 2 mm	%	1,5	

Start-up operations included the installation of the pilot plant and the preparation of all the hydraulic connections. At first, simple hydraulic tests were done to verify the flow and the functioning of all the equipment. Then, the columns were filled with adsorbent material, and all the meters were tested, with a particular attention to the fluorescence sensor, which needed a more deepened and specific study being innovative and never used at pilot scale to monitor adsorption processes.

To evaluate the reliability of fluorescence sensor for on-line monitoring purposes different tests have been done by collecting samples in the monitoring tank (Figure 32), where all the meters were located. Particularly, at the beginning the tank was completely filled with influent water, then the water was slowly replaced by the effluent water and several samples were taken with different mixing ratio (i.e., ratio influent/effluent) to obtain samples with different organic matter concentration. For all the taken samples the fluorescence value registered by the sensor was compared with the measurement obtained by a laboratory instrument (Shimadu Spectrofluorophotometer RF-6000) (Figure 33). Laboratory measurements have been also performed with filtered (0.45 µm) wastewater to identify possible interference related to the presence of suspended solids.



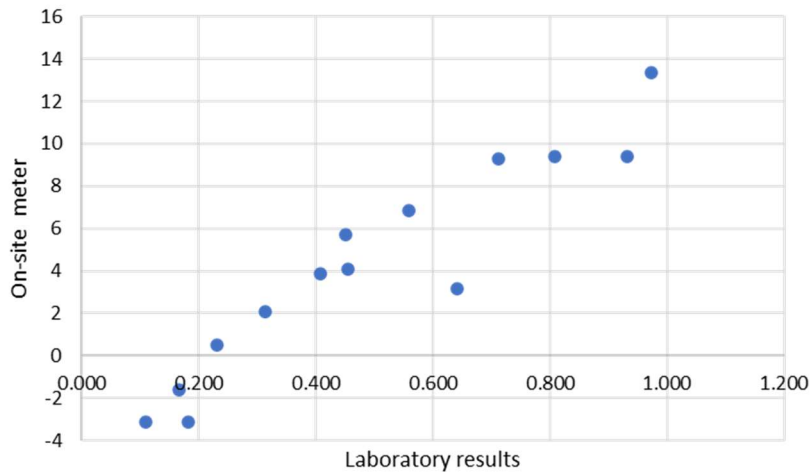

Figure 33. Calibration curve of fluorescence meter.

A very high correspondence was observed between laboratory data and on-site data registered by the meter (Figure 33). The sensor proved to be very sensitive to qualitative variation of the wastewater. For what concern the measurement of filtered/unfiltered wastewater, obtained measurements were pretty similar, and a very low and negligible interference of solid matter was detected during these initial monitoring operations. Example of fluorescence spectra of samples with different organic matter concentration obtained by laboratory instrument are shown in Figure 34.

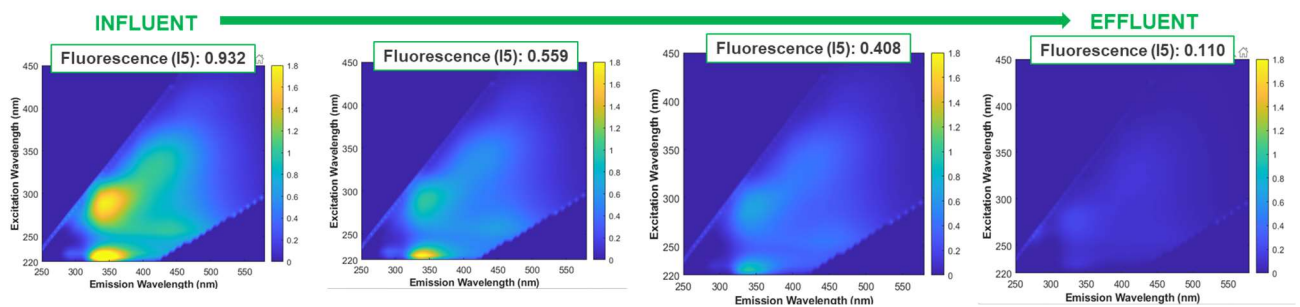

Figure 34. Fluorescence spectra of influent, effluent, and mixed (influent/effluent) samples collected in the monitoring tank of the adsorption pilot plant.

2.3.4. Results from laboratory and pilot plant operation and discussion

2.3.4.1. Laboratory tests to evaluate the adsorption properties of hydrochar

Hydrothermal carbonization (HTC) is a non-oxidative thermochemical process able to convert biomass (e.g., sewage sludge) into value-added products, including a carbon rich solid (i.e., hydrochar), a liquid (i.e., process water rich of nutrients) and gases (primarily CO₂) [9]. Particularly, the solid hydrochar has been proposed in literature as an alternative adsorbent material for wastewater treatment [7]. However, a preliminary activation procedure is needed before using hydrochar as an adsorbent, which can be performed by two different methods: physical or chemical activation. Physical activation is carried out using as activating agents, CO₂ or steam. Chemical activation



is carried out by mixing the raw hydrochar with chemical agents, such as potassium hydroxide KOH, sodium hydroxide NaOH or magnesium chloride $MgCl_2$ at high temperature [14].

The hydrochar investigated in this study was produced by HTC of sewage sludge. Particularly, a pilot-scale HTC system for sewage sludge treatment was operated in Tuscany (Italy) with the aim to gather knowledge and design parameters for a full-scale installation. Hence, it was possible to obtain around 100 kg of hydrochar produced from sewage sludge to be tested during our research activities.

Hydrochar from sewage sludge was activated at CPTM laboratory using a chemical activation procedure, which has been reported as the best activation method for hydrochar [14]. However, although physical or chemical activation processes of hydrochar can be easily performed at laboratory scale, several issues hinder the replicability of these processes at pilot/full-scale. Indeed, it was not possible to find a suitable reactor able to activate large amount of hydrochar (i.e., 100 kg) by physical or chemical processes. Hence, it was decided to test the adsorption properties of hydrochar after a slow pyrolysis process, which was a needed treatment to eliminate the very high leaching of organic material from the raw hydrochar.

The slow pyrolysis treatment of hydrochar (HC) was tested at laboratory scale, and the adsorption characteristics of the obtained material (pyrolyzed hydrochar - PH) were compared with those of the hydrochar after chemical activation (activated hydrochar - AH) and with those of a conventional GAC (i.e., the GAC utilized at ARETUSA plant).

The operative conditions of the activation process and of the slow pyrolysis process accomplished at laboratory scale are shown in Table 20.

Table 20. Experimental condition of chemical activation and slow pyrolysis of hydrochar.

CHEMICAL ACTIVATION OF HYDROCHAR	SLOW PYROLYSIS OF HYDROCHAR
<ul style="list-style-type: none">• Mixing of hydrochar with KOH (KOH to char ratio: 1:1).• Heating in a tubular oven up to 600°C (5°C/min heating rate), heating at 600°C for 1 hr, and cooling with N_2 purging.• Washing with 5M HCl and demineralized water (up to pH 7).• Drying at 105°C until constant weight.	<ul style="list-style-type: none">• Nitrogen Flux (N_2) to remove oxygen• Process temperature at 450°C• Retention time of 2 hours• Heating rate of 20°C/min.

First test to evaluate the applicability of hydrochar as adsorbent material was the leaching test, which was performed using raw hydrochar and activated hydrochar. Results of the leaching tests are reported in Table 21, where it is possible to observe a significant leaching of COD from the raw hydrochar. However, the activation procedure was able to eliminate this issue.





Table 21. Leaching test using Hydrochar (HC) and Activated Hydrochar (AH).

Parameter	Hydrochar	Activated hydrochar
F-	54.2	< 0,1
Cl-	44.4	1.7
Br-	< 0,1	< 0,1
NO ₃ -	1.3	< 0,1
PO ₄ ---	38.5	8.4
SO ₄ --	147.3	103.4
COD	4200	< 15

Since chemical activation of hydrochar is not feasible at pilot/full scale, further laboratory tests were performed to verify the elimination of COD leaching after pyrolysis treatment. Particularly, column tests at laboratory scale were performed to monitor COD release from hydrochar.

For this scope, two identical columns (adsorbant mass: 5 g, diameter: 1 cm) filled with raw hydrochar (HC) and pyrolyzed hydrochar (PH) were flushed by demineralized water with a flow rate of 0.04 l/h (i.e.; EBCT: 10 min). Results of the performed tests are reported in Figure 35, where monitored parameters were COD, UV absorbance at 254 nm (UV₂₅₄) (i.e., surrogate parameter for COD measurement), pH and conductivity. Figure 35 shows that the slow pyrolysis was able to eliminate the leaching of COD from hydrochar, and a very small amount of COD was released only during the first hour of washing. However, an increase of pH was observed in the water flushed from the PH column.



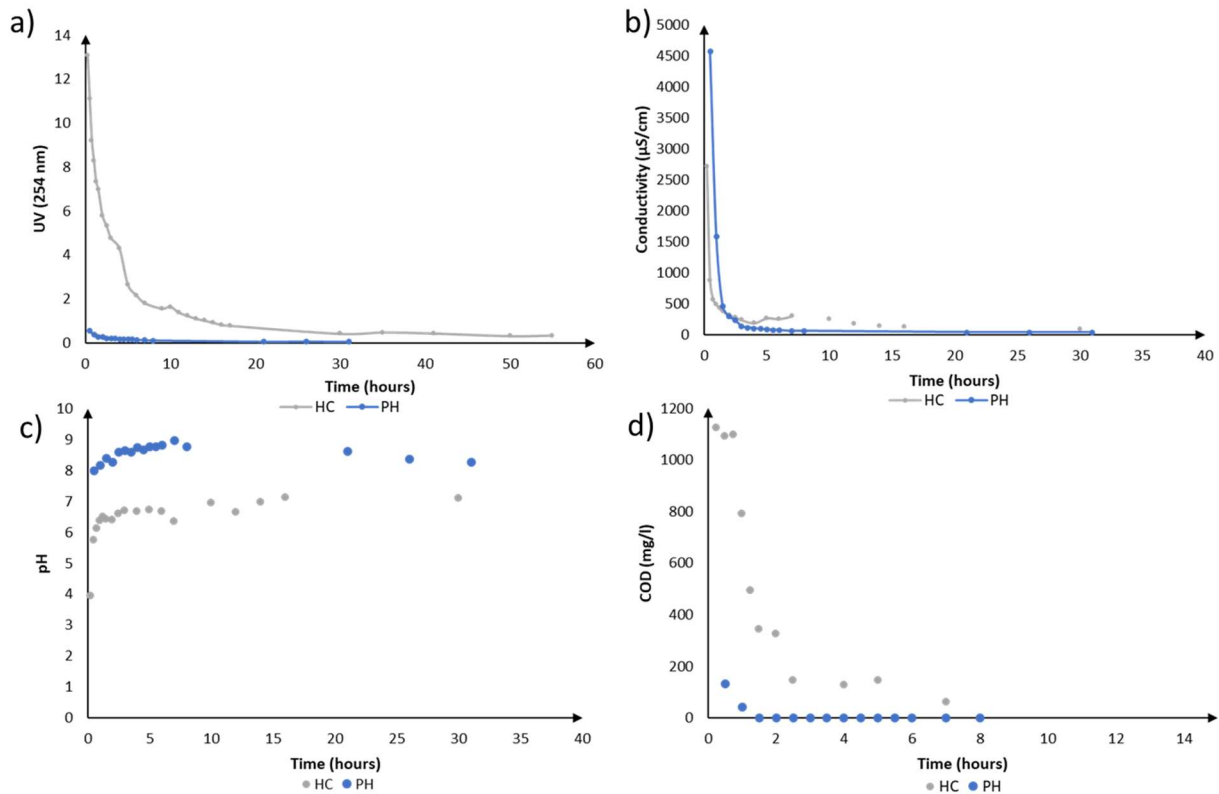

Figure 35. Washing tests in columns filled with Hydrochar (HC) and Pyrolyzed Hydrochar (PH). Monitored parameters included UV absorbance at 254 nm (a), conductivity (b), pH (c) and COD (d).

SEM analysis and BET surface analysis were performed to evaluate the adsorption properties of raw hydrochar, AH and PH. SEM analysis (Figure 36) showed that pores are not present on the surface of the raw hydrochar, whereas a significant porosity is present in the commercial GAC. After the chemical activation procedure, a significant porosity was also created in AH. On the contrary, an important increase of porosity was not observed in the PH. The value of BET surface area obtained for AH was comparable with that one of commercial GAC (Table 22). On the contrary, a small measurement of BET surface area was determined in the PH, whereas the measurement of this parameter resulted not detectable in the raw hydrochar. These results suggest that adsorption capabilities of AH may be relevant and comparable with those of commercial GAC, whereas lower adsorption performance is expected using PH.



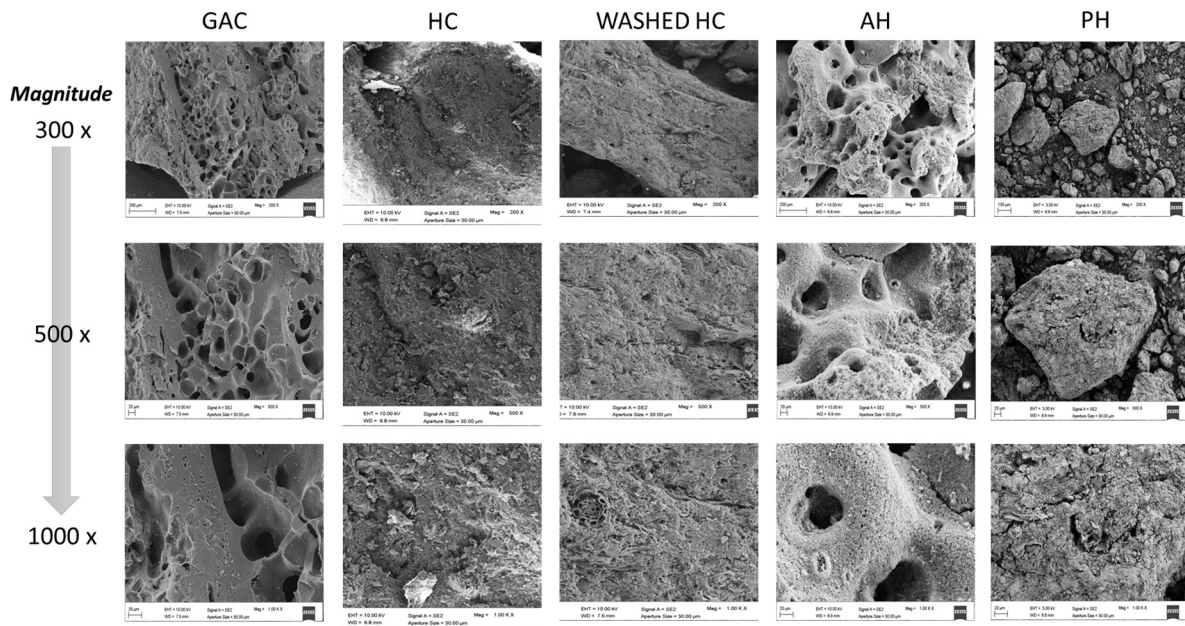

Figure 36. SEM analysis of commercial Granular Activated Carbon (GAC), Hydrochar (HC), washed Hydrochar, Activated Hydrochar (AH) and Pyrolyzed Hydrochar (PH).

Table 22. BET Surface Area of Hydrochar (HC), Activated Hydrochar (AH), Pyrolyzed Hydrochar (PH) and commercial Granular Activated Carbon (GAC).

Sample	BET Surface Area, m ² /g	Pore volume, cm ³ /g	Median pore width, Å
HC	ND*	ND	ND
AH	751.7	0.359	16.08
PH	100.42	0.0453	7.672
GAC	1100-1150	-	-

*ND: Non detectable.

Batch adsorption tests were performed at laboratory scale to evaluate the capability of raw hydrochar, AH and PH to adsorb organic material. Particularly, during the performed batch adsorption tests, it was evaluated the removal of COD from wastewater and of diclofenac (i.e., a pharmaceutical compound) from demineralized water.

Kinetic adsorption tests were performed dosing 0.1 g of GAC and AH and 0.05 g of PH material in 50 mL of wastewater (i.e., the primary effluent of Falconara Marittima WWTP filtered at 0.45 µm) or in 50 mL of diclofenac (DFC) solution (DFC concentration of 60 mg/L). Results of the kinetic adsorption tests are reported in Figure 37. The time needed to reach equilibrium conditions during COD adsorption was around 50 h for AH and commercial GAC, whereas almost 120 h were needed when using PH, which showed lower adsorption capacity. AH removed 100 mgCOD/gAH at the equilibrium conditions, which was higher than removal observed by GAC (72 mgCOD/gGAC) and PH (40 mgCOD/gPH). In the case of DFC adsorption, equilibrium conditions were reached in 20 h when using AH and around 80 h when using GAC. PH showed low



adsorption of DCF (4.6 mgDCF/gPH), whereas similar adsorption performances were observed using AH and GAC (4.6 mgDCF/gPH).

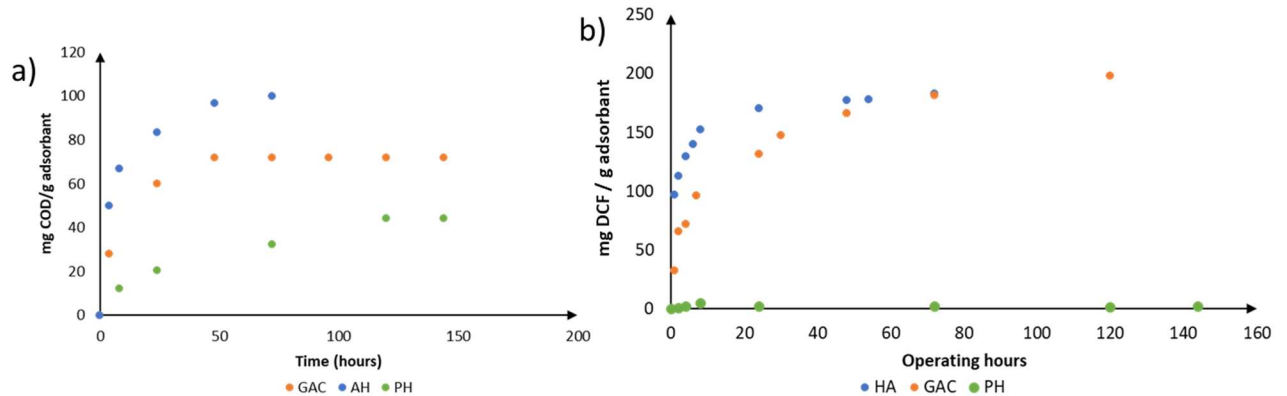

Figure 37. Kinetic adsorption tests for a) COD removal from wastewater, and b) DCF by using GAC, AH and PH. COD concentration was 84 mg/l for GAC test, 70 mg/l for AH test and 65 mg/l for PH test. Diclofenac concentration was 60 mg/l for all tests. Adsorbents dosages: 0.1 g of GAC, 0.1 g of AH and 0.05 g of PH.

2.3.4.2. Slow pyrolysis of hydrochar performed at pilot scale

The slow pyrolysis of hydrochar was committed to the company RE-CORD (<https://www.re-cord.org/>), which has a registered office in Viale Kennedy, 182, Scarperia e San Piero (FI), Italy. RE-CORD performed the slow pyrolysis of around 100 kg of hydrochar using a pilot plant (Figure 38) able to treat 100 kg/h of biomass. The plant can be operated continuously and is equipped with a local and remote-control panel. The process involves five significant stages:

- Feeding phase and entry of the biomass into the rotating drum
- Conversion of biomass in the absence of oxygen through the pyrolysis process obtaining biochar and raw pyrolysis gas (pyrogas)
- Re-combustion of the pyrogas produced, through specific low-emission burners and heat production for the pyrolysis process
- Gas cooling and chimney outlet
- Char outlet from the reactor and discharge into big bags



Figure 38. Rotary kiln for slow pyrolysis (PYROCK).





The plant operated at a process temperature of around 450°C (maintained inside the rotating drum) for a residence time of the material not exceeding 2 hours. For safety reasons, the char leaving the plant was wetted with water using nebulizers, allowing to limit the production of dust. In Table 23 are summarized the operative conditions maintained during the test.

Table 23. Operative conditions of slow pyrolysis performed at pilot scale.

Temperature (°C)	450
Flowrate of hydrochar (kg/h)	40
Residence time (min)	90

After the slow pyrolysis process around 30 kg of pyrolyzed hydrochar have been obtained (Figure 39) from an initial amount of 100 kg of raw hydrochar.



Figure 39. Pyrolyzed Hydrochar.

2.3.4.3. Adsorption pilot plant tests results and discussion

Adsorption tests accomplished at pilot scale started in September 2022 after the start-up operations and using the commercial GAC FILTERCARB CSC5. The pilot system was fed continuously with the wastewater effluent of the Falconara Marittima WWTP. At the beginning of the pilot operation, due to technical problems to a pressure valve (relief valve) located on the top of the column, very frequent backwash operations were needed since water outflows were observed with little increase of the pressure (Figure 40). When this technical issue was solved and the valve repaired, the frequency for backwash operation was reduced to once per week to avoid a wide decrease of flowrate (Figure 41).



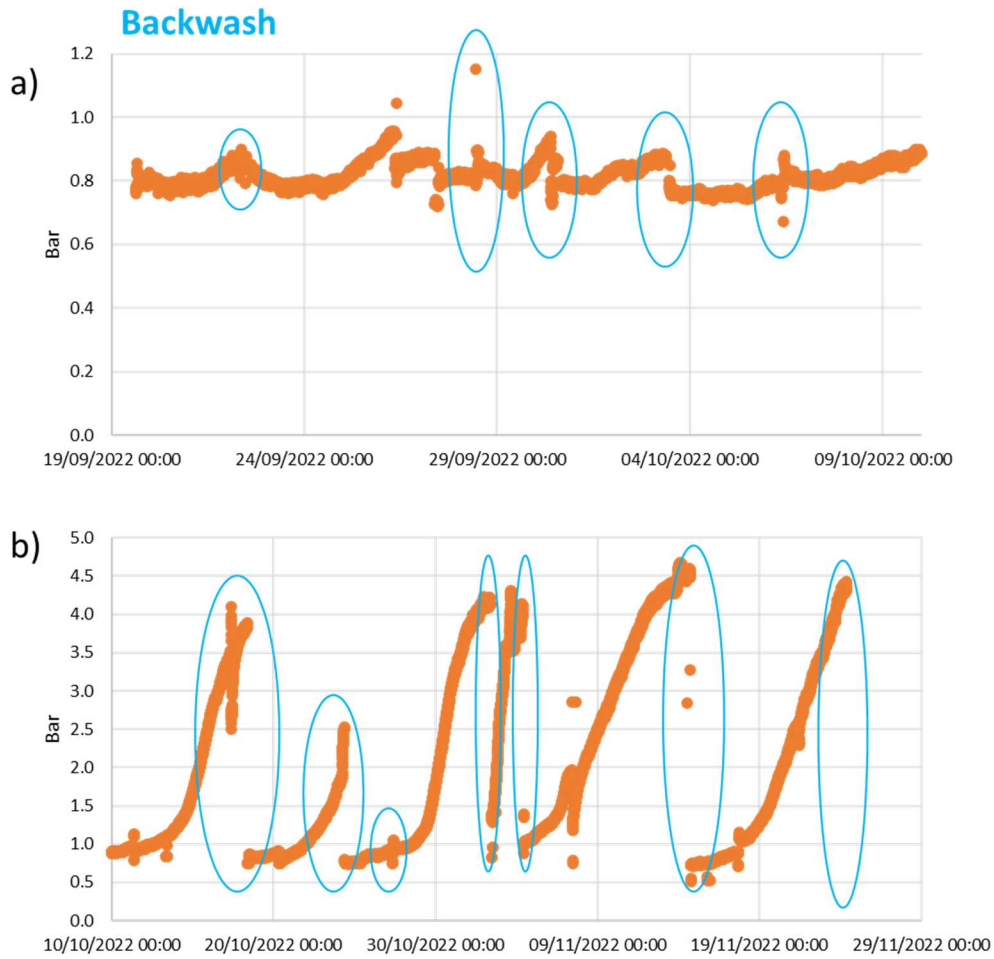

Figure 40. Pressure trend before (a) and after (b) maintenance of the relief valve.

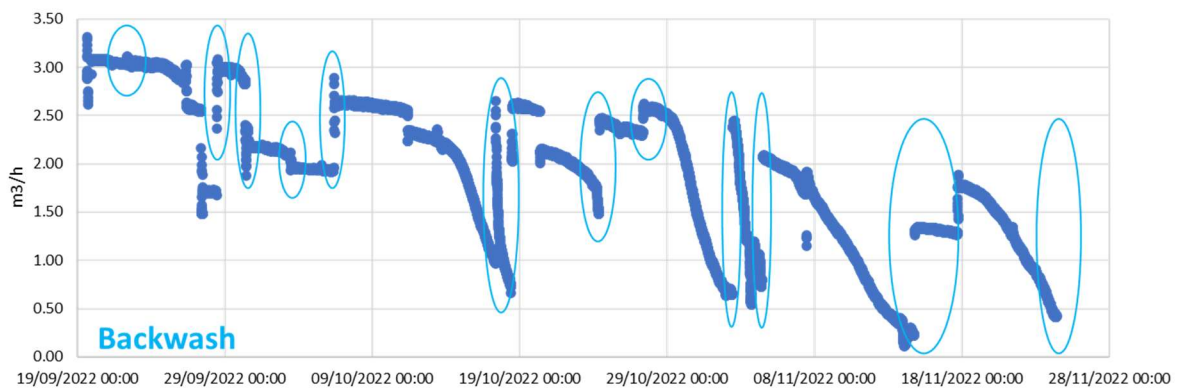

Figure 41. Flowrate trend during the pilot plant operation.

In Figure 42 is reported the trend observed in the effluent of the adsorption pilot plant for measurements provided by the UV₂₅₄ sensor and the fluorescence sensor. The trend observed for the two measurements was different, and the fluorescence sensor showed higher performance to detect promptly changes in wastewater organic matter concentration.



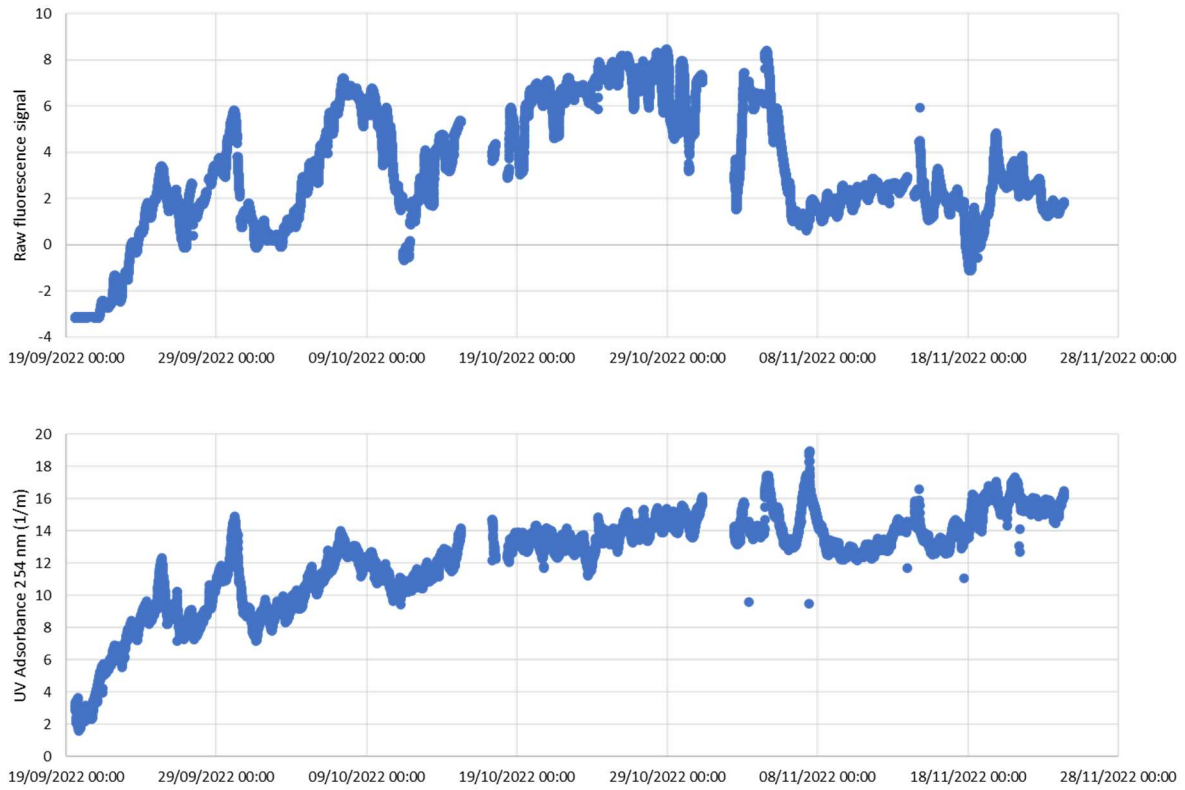

Figure 42. UV and Fluorescence trend.

During the monitoring period, two samples per week have been taken to measure UV absorbance and Fluorescence by laboratory instruments for both influent and effluent of the pilot. In Figure 43 are shown obtained results, where it is possible to observe that the fluorescence measurements have higher sensitivity to detect differences in organic matter concentration between the influent and effluent wastewater of the pilot system.

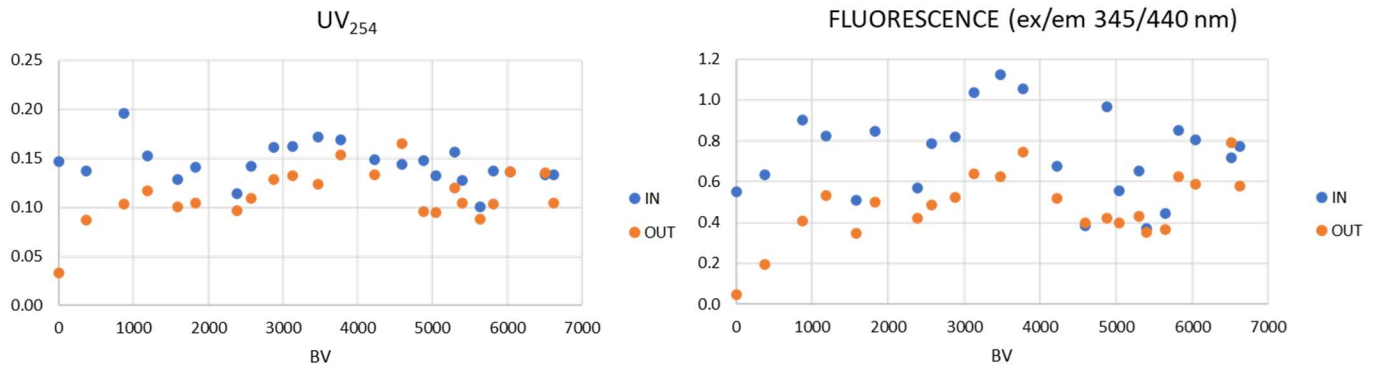

Figure 43. UV and Fluorescence laboratory measurements on influent and effluent samples from the pilot plant.

In Figure 44 is reported a comparison between sensor measurements accomplished by sensors and at the laboratory. It is possible to observe a much higher consistency between laboratory and sensor data for fluorescence measurements than for UV absorbance measurements.



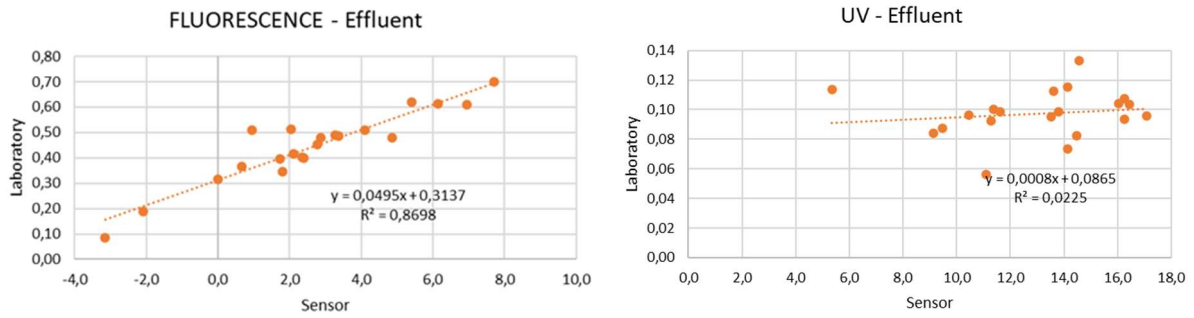

Figure 44. Comparison between laboratory and sensors measurements of fluorescence at ex/em 325/445 nm and UV absorbance at 254 nm.

During the adsorption monitoring period, collected samples have been analysed to determine the concentration of dissolved organic carbon (DOC) and of some pharmaceutical and personal care compounds. Few data are available for the concentration of these compounds in the investigated wastewater. Some of the obtained data are reported in Figure 45.

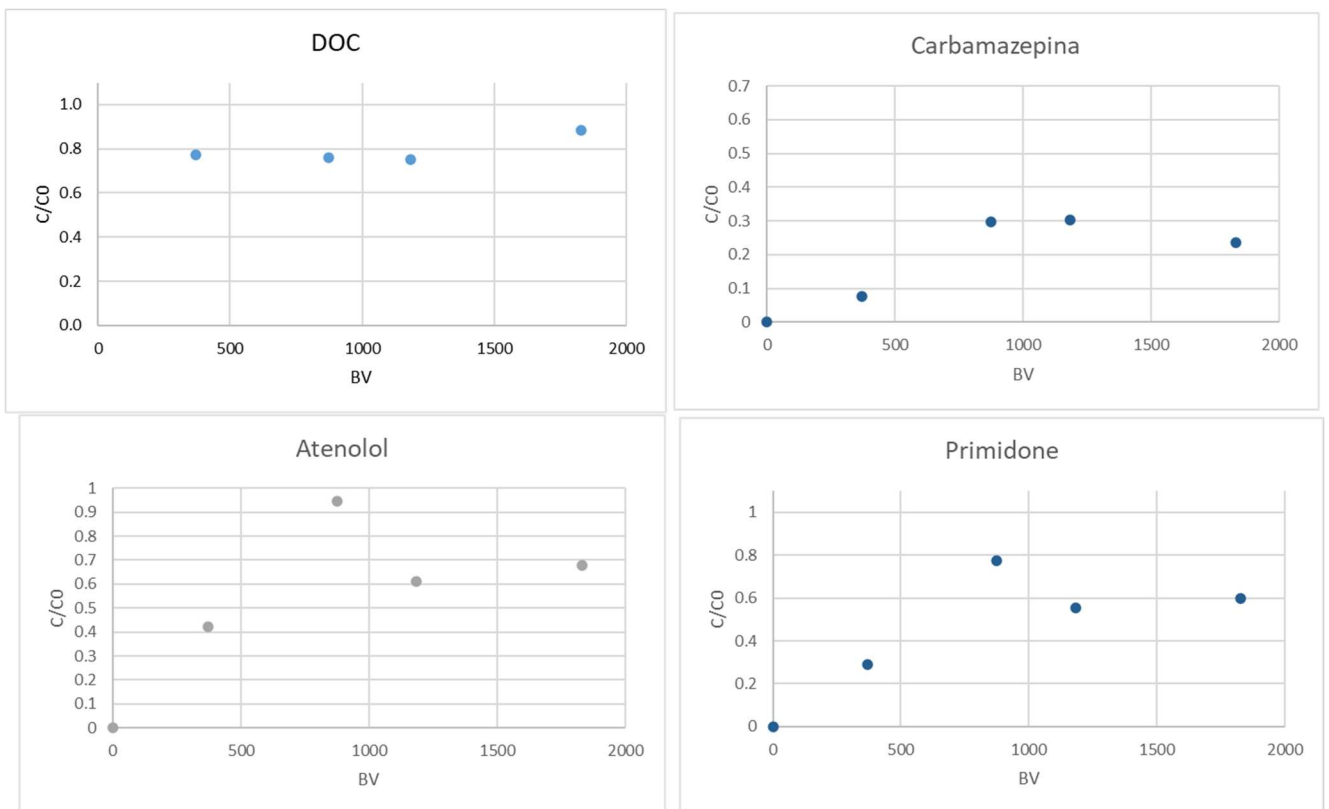

Figure 45. Monitored breakthrough for DOC and some emerging contaminants at the adsorption pilot system.

When a substantial set of data for DOC and emerging contaminants concentrations will be available, mathematical elaboration will be performed to find possible relationships between spectroscopic measurements obtained by sensors (i.e., UV₂₅₄ and fluorescence) and micropollutant/DOC concentrations.





2.3.5. Case study main conclusions

The pilot plant adsorption system (flowrate: 0.5-3.5 m³/h) designed in the frame of CS3 has the objective of reducing organic loads from municipal wastewater treatment plant effluent, using innovative materials (e.g., Hydrochar) as well as commercial carbons as adsorbent materials. The main innovations connected with the installation of the adsorption pilot plant are related to the use of alternative adsorbent materials derived by thermal treatment of waste sewage sludge, and on the use of innovative spectroscopic sensors (based on fluorescence measurements) to monitor the organic content in wastewater.

The main challenge faced for the implementation of the pilot system was the activation of Hydrochar, which has to be tested as alternative adsorbent. Activation procedures performed at laboratory scale were successful to produce promising adsorbent from hydrochar. However, the implementation of this process at pilot-scale to treat large amount of material is still challenging. Indeed, it was impossible to find companies or research institutes able to activate the required amount of material. Hence, it was decided to treat the hydrochar by slow pyrolysis to eliminate the large leaching of organic material from the hydrochar occurring when this material is flushed by water. The slow pyrolysis process was performed at pilot-scale, and it treated 100 kg of hydrochar. The pyrolyzed hydrochar was characterized by low adsorption capacity if compared with hydrochar treated by chemical activation at laboratory scale.

To avoid major delays in the start-up of the pilot plant, it was decided to start the pilot with commercial carbons while finalizing the activation of Hydrochar by pyrolysis. For this reason, the main results reported in this document regards commercial carbons. In the following months the activated Hydrochar will be tested too, and main results will be collected and reported.

Start-up of the pilot system was accomplished in July 2022 and it was focused on the calibration of the fluorescence sensor, which proved to be more sensitive than UV absorbance sensor in monitoring organic matter variation. In September 2022 the pilot system was fully operational, and the real-time monitoring activities started. The main difficulty faced during the operation of the pilot was the malfunctioning of the pressure valve which forced us to perform frequent backwashing. However, the valve was repaired after the first three weeks of operation. During the monitoring period, two samples per week have been taken to measure UV absorbance and Fluorescence by laboratory instruments for both influent and effluent of the pilot, and to perform comparison between on-line and off-line measurements. In general fluorescence measurements proved to have higher sensitivity than UV to detect differences in organic matter concentration between the influent and effluent wastewater of the pilot system. When a substantial set of data for DOC and emerging contaminants concentrations will be available, mathematical elaboration will be performed to find possible relationships between spectroscopic measurements obtained by sensors (i.e., UV254 and fluorescence) and micropollutant/DOC concentrations.





2.4. CS4 Nafplio (Greece)

2.4.1. Brief description of the case study and objectives

The eastern Peloponnese is one of the most productive regions in Greece in terms of citrus fruit (it is to be highlighted that Greece is the third largest producer of citrus fruit in the EU). Alberta S.A. is a Greek fruit processing industry and specialises in the production of fruit juice concentrates, fruit purees and concentrates, clarified juice concentrates, NFC juices, as well as tailor made products and blends, since 1981. It produces juices not only by fruits but also by vegetables, like carrots and red beets. Its main fruit juices come from citrus fruits (oranges, lemons, grapefruits, and mandarins), pome fruits (apples, pears), stone fruits (peaches, apricots), pomegranates, chokeberries, grapes, carrots and red beets.

Particularly in the Argolida area, where CS4 is placed, there is an increasing water demand for irrigation purposes, due to the fact that most water comes from irrigation wells, which are often not legal. This practice, along with the high-water consumption of the fruit processing industry, is exerting great pressure to the local aquifer. Over-irrigation has led to subsequent intrusion of the seawater into the aquifer, which has diminished the quality of the groundwater aquifer, which is presenting high conductivity values (around 3000 $\mu\text{S}/\text{cm}$).

With a view on reducing the overall cost of disposing wastewater to the municipal biological treatment and meet the effluent criteria, all sizeable fruit processing plants of the area have constructed and are currently operating individual primary biological units. However, each unit needs to be periodically stopped, due to the seasonality of the fruit processing industry. This procedure increases operational costs, as it is necessary to restart the unit when needed. No symbiosis among stakeholders of the area is established at this point, which would enable water reuse or recovery of any valuable resource.

Alberta S.A has a primary biological treatment unit of about 20 m^3/h capacity to meet the effluent criteria, as well as to reduce the cost of disposing wastewater to the municipal WWTP. This process is mainly focused on the removal of organic matter, achieving more than 90% removal (COD concentration in the outlet stream $<400 \text{ mg O}_2/\text{L}$). Currently, inlet and outlet water streams are not monitored regularly. Before the Covid-19 pandemic, during the high production period (usually during citrus production from November until March and grape/pomegranate production from August to October), the capacity of wastewater treatment was about 3500 m^3/d . During the rest of the year, this capacity was reduced to about 500 m^3/d . In 2020, due to the Covid-19 restrictions, the wastewater flow decreased to around 200 m^3/d during the summer and 360 m^3/d during the winter, on average.

ULTIMATE's main aim in CS4 is to establish, extend and reinforce the symbiotic relationship of Alberta with the fruit processing sector and the water service provider, by reducing the freshwater demand and its production costs (which implies reducing the cost of the primary treatment and the cost related to the high COD of the wastewater), while generating revenues from the possible exploitation of the extracted value-added compounds.





Additionally, this treatment plant will lead to overall reduction on the cost of water usage, while the municipal biological treatment unit will receive and treat wastewater of better quality, decreasing the strain and the operating cost of its operation. The aim after the implementation of the pilot wastewater treatment process is to achieve lower organic burden in the final effluent, compliant to the limits specified by the local water management authority, either for disposal to the local final treatment unit, irrigation or reuse in the production procedure of Alberta S.A.

2.4.2. Technological solution in ULTIMATE project: pilot plant description

The unit has been already fully deployed at the quarters of Alberta S.A. (Figure 46), along with the control and operation additional units, in the diverse and mobile of two 20 feet containers modified into treatment tanks and a metal ISOBOX containing the electrical installation and control units.



Figure 46. CS4 pilot plant deployed at Alberta S.A.

The processes that are employed in the mobile unit were tested in lab scale to help us predict the necessary sequence. The overall process is described by the following layout (Figure 47):



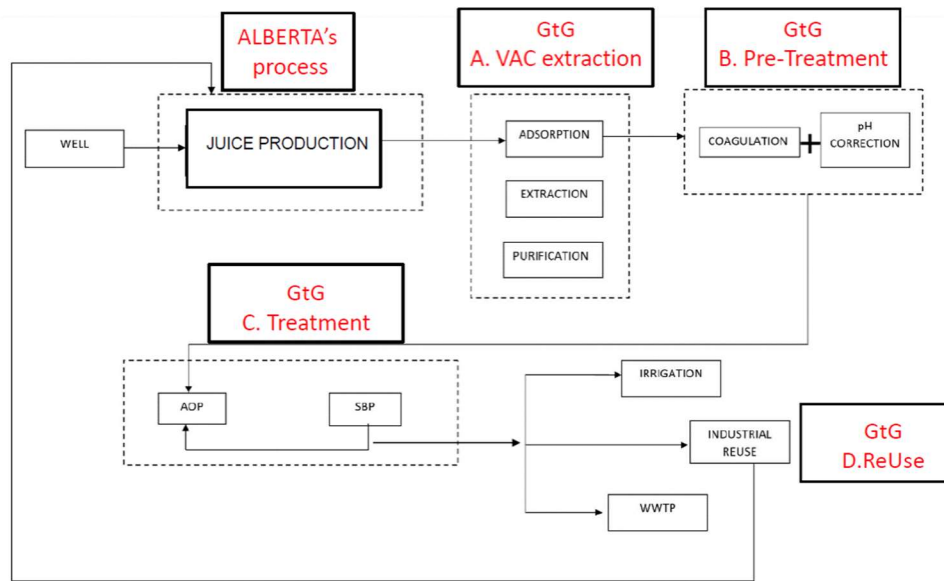

Figure 47. Layout of the pilot process deployed at Alberta S.A.

The pilot comprises of the following components:

A. VAC adsorption /extraction unit

This unit employs a series of adsorption, extraction, and purification steps to accommodate the optimal recovery of value-added compounds. The extraction should be prior to any other physical or chemical process. This unit addresses also the objectives of substask 1.4.3 (Recovery of high-added-value compounds in Nafplio). More details are presented there.

Based on the results of extensive laboratory experiments, the type of adsorptive material, contact time and maximum adsorption capacity, where selected and upscaled to fit the described pilot unit (Figure 48).

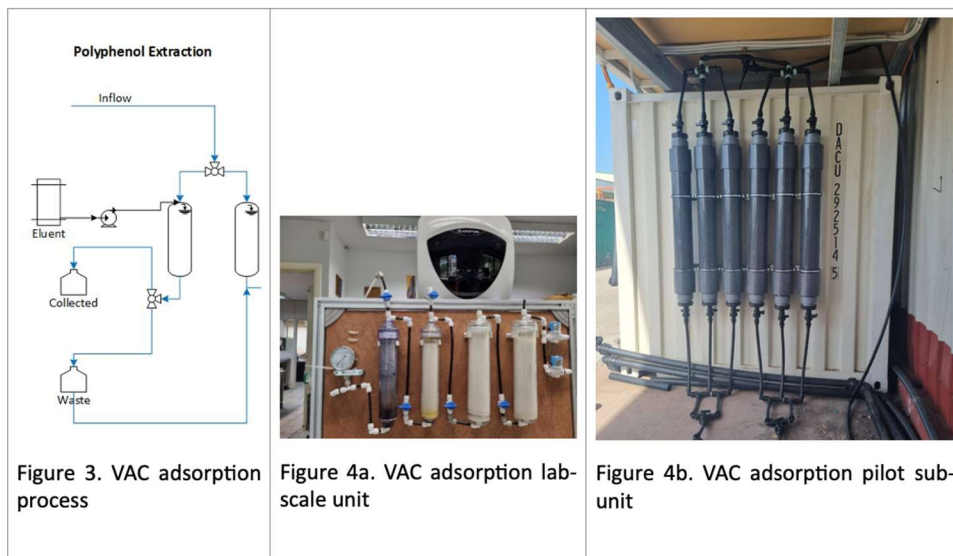

Figure 48. VAC adsorption process, VAC adsorption laboratory scale unit and VAC adsorption pilot sub-unit.



B. Pre-treatment

After removing organic compounds of high value, water is further treated to remove suspended or dissolved solids using coagulation, by manipulating electrostatic charges of particles suspended in water, via the addition of polyaluminum-electrolytes at a specific range of pH (1st container). Settled solids are removed and clean water is regulated to a specific pH range to be further treated using an Advanced Oxidation Process (AOP).

C. Treatment of organic load

C1. Advanced Oxidation Process (AOP)

In this step, organic compounds are degraded via highly active, oxidative species (hydroxyl radicals), which are produced using a combination of UV irradiation (artificial UV source) and either a semiconducting catalyst (e.g. TiO₂) or hydrogen peroxide (H₂O₂) at various irradiation wavelengths. This step is particularly important in case of the presence of:

1. Low biodegradability compounds as they are not effectively removed by biological treatment, or toxic materials.
2. Toxic compounds that kill the biological treatment microorganisms.
3. Predator organisms that feed on the biological treatment microorganisms.

The overall aim of this step is to either totally mineralise organic compounds or to partially break-up organic compounds which are resistant to various degradation processes to finally biodegrade them in the next treatment step (SBP).

For our purposes, we have employed two different types of photocatalytic reactors:

- A CPC photocatalytic reactor (Figure 49), which could operate using all photocatalytic systems (heterogeneous, homogeneous, slurry or immobilized catalyst etc.), under either solar or artificial light has been designed and constructed. The reactor has been tested as an individual technology under solar and artificial light using TiO₂ photocatalyst.
- A closed annular photocatalytic reactor, able to include different artificial irradiation sources and chemical additives, to facilitate more effective and intensive organic degradation. This unit has been developed, employed, and has not started its operation yet.



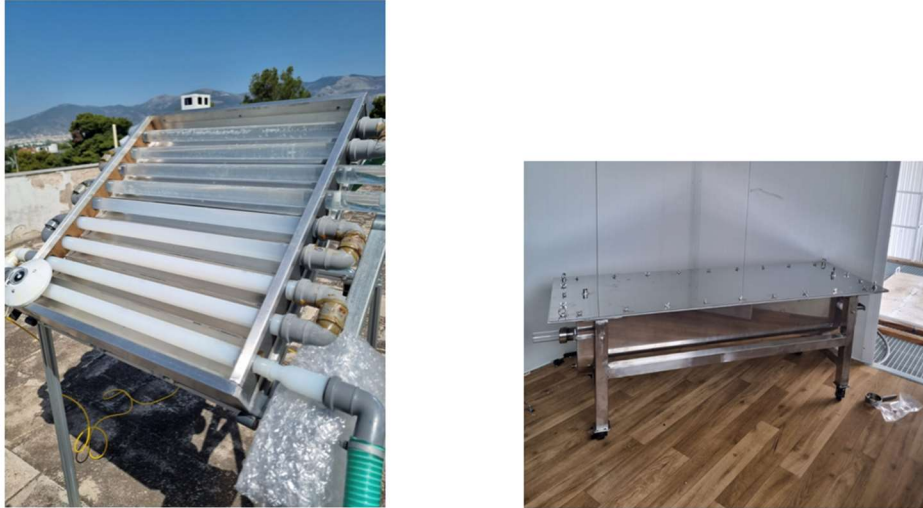

Figure 49. CS4 photocatalytic reactor.

C2. Small Bioreactor Platform (SBP)

This unit comprises of a bioreactor that will only operate if deemed necessary. The combination of AOP and SBP can lead to a significant reduction on time and cost of the water treatment process, while increasing the overall the process' efficiency.

The SBP is a form of biological treatment in capsules, which means that microorganisms are encapsulated in porous material, giving them specific advantages as regards to stability, limits of operation and simplicity of application/removal.

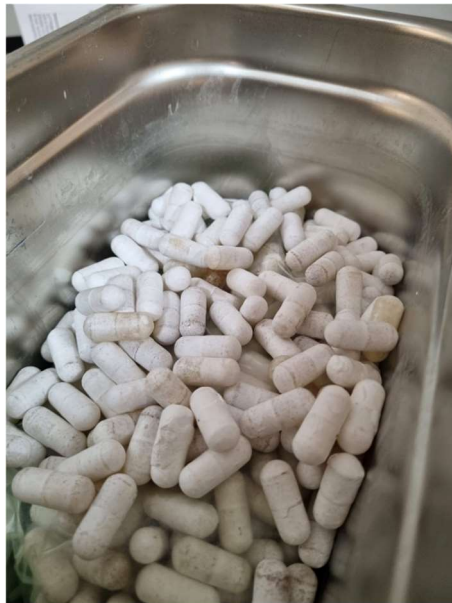

Figure 50. SPB capsules.

System control and operation

The whole system is controlled remotely by an extensive system of sensors that have been installed in the ISOBOX (Figure 51). The efficacy of the unit's operation is monitored using a series of pH, TSS etc sensors and an online Total Organic Carbon (TOC) Analyzer.



Figure 51. CS4 pilot plant sensors, control unit and TOC analyzer.

2.4.3. Start-up operation

The CS4 pilot was set-up and the tested/calibrated by performing control experiments. Initial tests were performed on an abundant, frequently produced, and common type of wastewater (Table 24). Initial pilot experiments were conducted with the following operating conditions (

Table 25).

Table 24. Wastewater for start-up operation.

Wastewater TYPE 1 – Orange juice production	
TOC	2300 mg/L
pH	6.6
TSS	< 400 mg/L



Table 25. Start-up operation conditions.

Operational Parameter	Value
Flow rate	10 m ³ /day
Duration of operation	8 hours/day for 5 days
Addition of NaOH / HCl	Adjustable
Addition of H ₂ O ₂	Variable
Air sparging in AOP	Variable

Experiments on specific streams of the production line will be performed. The unit is still optimised to run under different stream of production lines and with various wastewater types.

2.4.4. Results from laboratory scale tests and discussion

2.4.4.1. Recovery of high-added-value compounds (antioxidants) in Nafplio

Over 80% of the polyphenols present in the orange juice by-product are successfully adsorbed on the resin. During our lab tests we worked both with olive and orange by-products and we performed hot water – methanol extraction. Hot Water-methanol mixture (50:50 b.v.) yielded 69% polyphenols recovery (Figure 52).

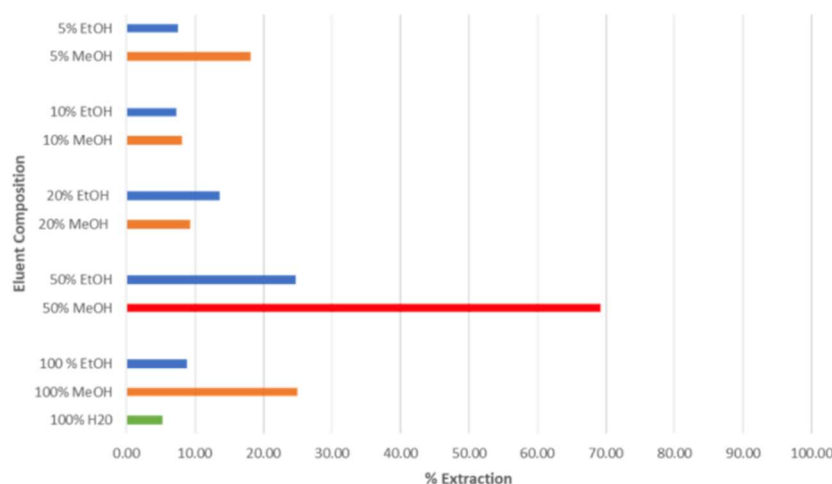

Figure 52. Effect of various extraction solvents in the recovery of VACs from sorbent material.

The following days we will be working on the optimization of the Subcritical water extraction (SCWE) unit.



2.4.4.2. Reuse of fruit processing wastewater in Nafplio

Lab-scale experiments have shown that pre-treatment steps (filtration, polyphenols adsorption, pH adjustment and coagulation) achieve 50% reduction of the TOC and the remaining wastewater is colourless, odourless, and free of solids (Figure 53). The first pilot plant results are analogous with the results from the lab experiments.



Figure 53. Pre-treatment steps of orange production line by-product.

The Solar AOP reactor has been tested. Our initial results have shown that it degrades model compounds. The following figure presents the degradation of 2,4-Dichlorophenol (Figure 54) and the degradation efficiency was similar when Sunset Yellow was used as a model compound. Nevertheless, it seems to partially degrade organic molecules, since there was no significant reduction of the TOC. This measurement seems to be inappropriate for measuring the performance of this specific step, as the aim is to break the molecules into smaller that the microorganisms of the SBP will degrade easily. Therefore, TOC will be used to monitor the overall performance of the unit.

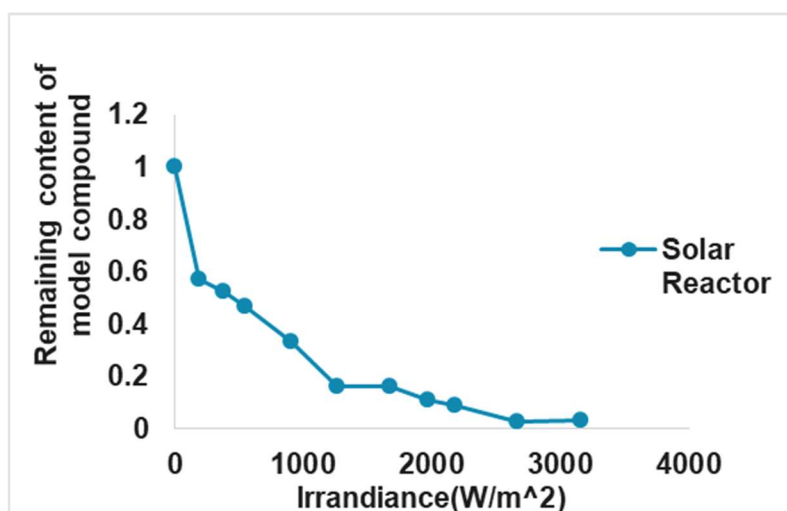



Figure 54. Degradation of a model organic compound using the CPC solar reactor.

The annular AOP reactor is placed in the unit and currently we are working on optimising its performance.

The SPB platform has not yet been tested due to its high cost. We will optimise all the others steps first and then we will test them.

2.4.5. Case study main conclusions

Greener than Green Technologies has completed the assembly of the proposed pilot unit at our partner Alberta, in Nafplion, Greece. It has the capacity to treat 10m³/day of water by product originating from various juice production streams. The pilot unit is currently operational, though we are still facing teething issues mainly piping leaking and automation issues. We are currently working to integrate more features of the pilot unit under the automation platform. Several safety issues are still being addressed, such as electrical safety, leakage management and UV radiation safety. Our aim is to render the unit safe for non-trained/specialised personnel.

On the recovery aspect of polyphenols, we have finalized the low cost/efficiency protocol and scale up results agree with lab scale experiments. Currently we are optimising the subcritical water extraction methodology, while making improvements on the process design. One issue that we need to address to make the process more cost effective is to find alternatives to the extremely high-priced adsorption material. Moreover, we believe it is imperative to migrate towards more environmentally friendly and circular material. To address these adsorption issues simultaneously we will look into natural alternatives as well as preparation/production processes.

Finally, one of the major challenges we are facing is streamlining the process so that it is more cost effective. As we are currently targeting very high-priced value-added compounds this cost, though significant, is acceptable, by reducing the cost we can target value-added compound of lower market price. This will increase our addressable market and make our technology/product more attractive to a wider range of industries. Simultaneously, in this way and in conjunction with our proposed business model, we will reduce the environmental footprint of our business, a subset deeply embedded in the company culture.

Several ideas have been proposed, with the most prominent one being the reduction of the bulk of the unit, that will make it easier to transport between sites, hence both reducing the costs and environmental impact.

2.5. CS5 Lleida (Spain)

2.5.1. Brief description of the case study and objectives

In Lleida, the water smart industrial symbiosis exists since 2009 and interlinks the Mahou San Miguel (MSM) brewery with the multinational water utility Aqualia as well as with the local municipal utility of Lleida and the Catalan Water Agency.

The brewery has its own wastewater treatment plant. However, up to now, no water is reclaimed, no bioenergy is produced, and no nutrient is recovered in the WWTP. On average, 98% of the COD is biodegraded aerobically to CO₂ and sludge, and 90% of the nitrogen is eliminated via microbial uptake for growth. The phosphorus is only





partially removed by approximately 30% likely due to a microbial uptake for growth. The effluent from the secondary clarifier enters the municipal sewer system and the biosolids are disposed to an external sludge management. Around 9.4 t of dried sludge are daily produced and sent to an external composting plant.

From this baseline, CS5 proposes actions in the three vectors of ULTIMATE:

- Water: Mahou San Miguel desires to reduce its water consumption by 10% by 2025, which shall be demonstrated by the ULTIMATE solution for water reclamation, in which Pentair XFlow participates actively with nanofiltration technology. Moreover, a novel technology combining a conventional ultraviolet-based technology (for disinfection) with advanced oxidation process (AOP) will be tested.
- Energy: An ElectroStimulated Anaerobic Reactor (ELSAR®) will be tested in a pre-commercial scale (treatment capacity around 20 m³/h), having the aim of maximize the highlights of anaerobic digestion as wastewater treatment solution: low energetic requirements, biogas production, low sludge production, low nutrients need. This will suppose a radical change to the existing wastewater plant.

As an alternative high-performance anaerobic treatment, a smaller Anaerobic Membrane Reactor (treatment capacity around 2 m³/h) is going to be compared to ELSAR. AnMBR technology combines anaerobic digestion process, for organic matter removal with an ultrafiltration process, for separating the clean effluent from the anaerobic sludge.

Energy in the anaerobic smart-water solutions of CS5 shall be recovered in the form of biogas and be converted as efficiently as possible to electricity and heat. This conversion will be done through a demo-scale Solid Oxide Fuel Cell. This increase in efficiency is aligned with Mahou San Miguel's commitment on carbon footprint reduction.

- Nutrient: A concept study for nutrient reclamation (by means of struvite and hydrochar) in a real municipal WWTP and a real industrial WWTP, respectively, will be driven.

2.5.2. Technological solution in ULTIMATE project: pilot plant description

2.5.2.1. Water reclamation technological solution

After evaluating different options, the most feasible water reclamation opportunity was to:

1. regenerate the wastewater after the secondary treatment in the current WWTP.
2. reuse the regenerated wastewater as cooling water in existing cooling towers.

The water to be regenerated comes from the Mahou San Miguel WWTP, consisting of an activated sludge system without removal of nutrients and conventional settling. It is therefore an industrial water after secondary treatment. In the Table 28 the characterization can be found.





Mahou San Miguel wants to reuse the regenerated water in existing cooling towers, with a maximum consumption (during the production season) of 10 m³/h. Royal Decree 1620/2007 includes the requirements for this use in its section 3.2.a.

Table 26. Water quality requirements for reuse in cooling towers according to Royal Decree 1620/2007 (section 3.2.a).

Parameter	Requirement	Units pH
Legionella' spp	Absence	CFU/1L
Nematode eggs	<1	eggs/10L
'Escherichia coli	Absence	CFU/100ml
Suspended solids	<5	mg/L
Turbidity	<1	TNU

Additionally, cooling towers require electrical conductivity below 400 μ S/cm, ideally around 200 μ S/cm. Finally, the water should not be corrosive, the degree of which is measured by the Langelier index, which should ideally be as negative as possible.

Finally, to ensure the disinfection and to increase the quality of the regenerated water, Aqualia developed an innovative solution that combines disinfection through ultraviolet (UV) and an advanced oxidative process (AOP) for emerging pollutants removal. Big industrial water consumers, like food and beverage (i.e. including breweries) are concerned about the presence of micropollutants in process waters. Although most of these compounds could be separated by reverse osmosis (RO), RO may be a costly solution, that produces brine and that doesn't really destroy micropollutants (they are only separated). Thus, there is a real motivation for an alternative smart-water industrial solution.

Once known the quality of the wastewater (input) and the required quality of the cooling water (output), it can be easily seen that the treated water does not meet the requirements to be reused. There is a need of remove turbidity, suspended matter, microorganisms and salts. Therefore, a membrane-based solution was considered.

Nanofiltration (NF) is a novel membrane technology, with pore size between the reverse osmosis (RO) and ultrafiltration (UF). It can remove not only suspended matter, as the UF, but also, to some extent, some dissolved matter, particularly heavy ions, like sulphates, or long-chain organic compounds. NF is commonly known in treatment of surface waters, but there is lack of knowledge by applying it to treated wastewater.

In order to get the proof-of-concept of the NF application to treated wastewater, previous tests were driven in February 2021 through a lab-scale NF unit with 2 membrane pore size: 400Da and 800Da, respectively. The main results are shown in the following charts.



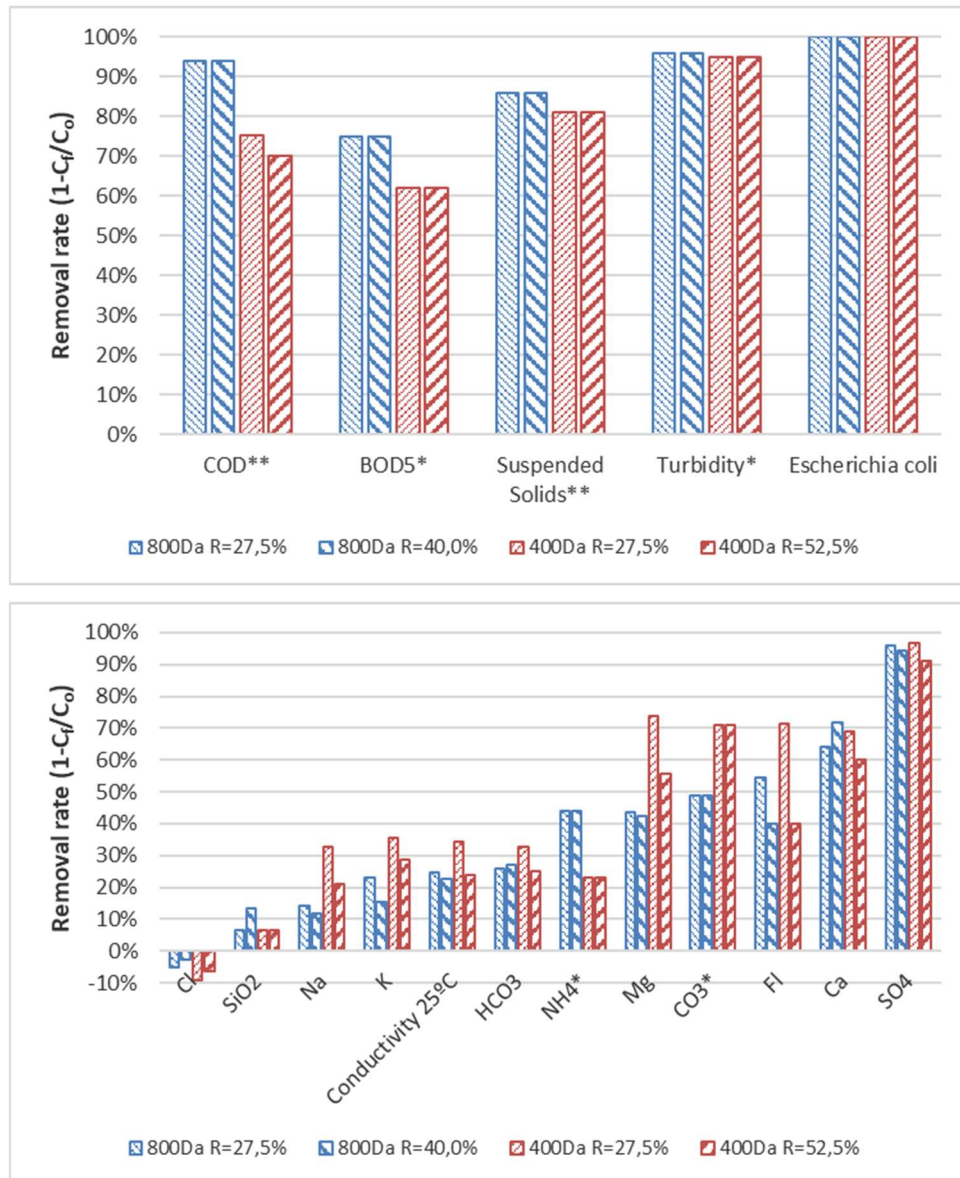

Figure 55. Top: Removal rate of organic matter and microbial indicators in 400 and 800Da NF membranes, respectively, at a given recovery rates. Bottom: Removal rate of minerals and electrical conductivity in 400 and 800Da NF membranes, respectively, at a given recovery rates.

As can be seen, from the point of view of the quality of the water obtained, the nanofiltration (NF) technology is validated for the regeneration of treated wastewater in Mahou San Miguel for use in cooling towers, according to the current reuse regulation. However, NF removes electrical conductivity only to some extent (<30%), which makes necessary to propose a RO post-treatment that meets the needs for desalinated water. In addition, a second membrane provides a multi-barrier approach to the solution.

The fact of using an RO in turn reinforces the need for a previous NF, since it retains dissolved organic matter (COD, BOD₅) to a greater degree than other membranes such as ultrafiltration (UF); with this, the NF minimizes the fouling of the RO.



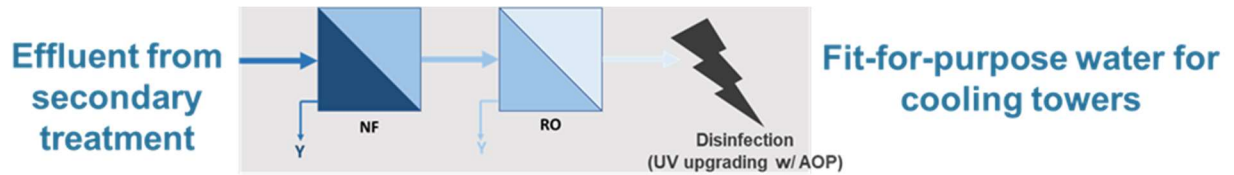

Figure 56. Scheme of the proposed water reclamation solution in CS5.

The experience in Mahou San Miguel shall demonstrate a comprehensive and realistic industrial-smart water reclamation case. Thus, the treated water will be really reused in cooling towers. Because the RO water is poor in minerals and, therefore, corrosive, a remineralization step is necessary (not shown in the previous diagram). Reverse osmosis brine (from another application in the brewery) has been used for this blending step. A pump is also present to send the final blended water to the cooling towers.

Pentair/Xflow, as a partner in ULTIMATE, supplies the 2 m³/h NF pilot plant, fully equipped, consisting of a 20-foot container that houses an electrical panel, a membrane module and peripherals, with a capacity of 40 m² of nanofiltration surface. Aqualia is in charge of the installation, operation, supervision and disassembly.



Figure 57. Pictures of RO (left) and NF (right) pilot plants used for the water reclamation case in CS5.

The goal is to achieve maximum performance with the most stable process possible. The main operation parameters to be modified were filtration flux, crossflow velocity, recovery rate and cleaning frequency. The following chart shows the considered value for each week.



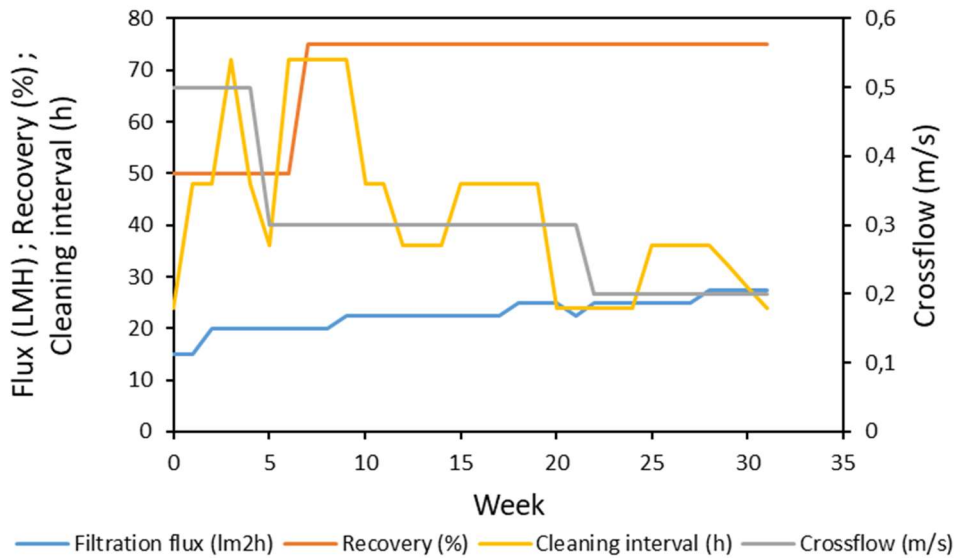

Figure 58. Weekly evolution of NF pilot plant conditions in CS5.

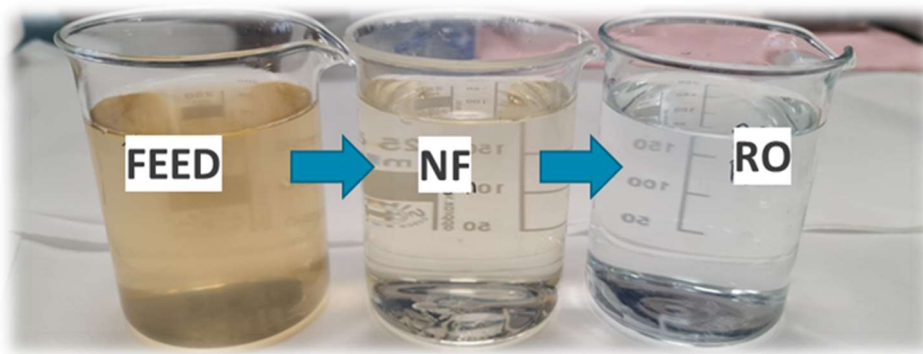

Figure 59. Picture comparison of the three different streams: wastewater after secondary treatment, nanofiltration and reverse osmosis.

After each filtration period, the membrane is cleaned using a hydraulic cleaning cycle. After several hydraulic cleanings, the membrane is subjected to a more intensive chemical cleaning. The frequency and duration of both cleanings can be adjusted depending on circumstances, such as the quality of the water to be filtered (Figure 60).

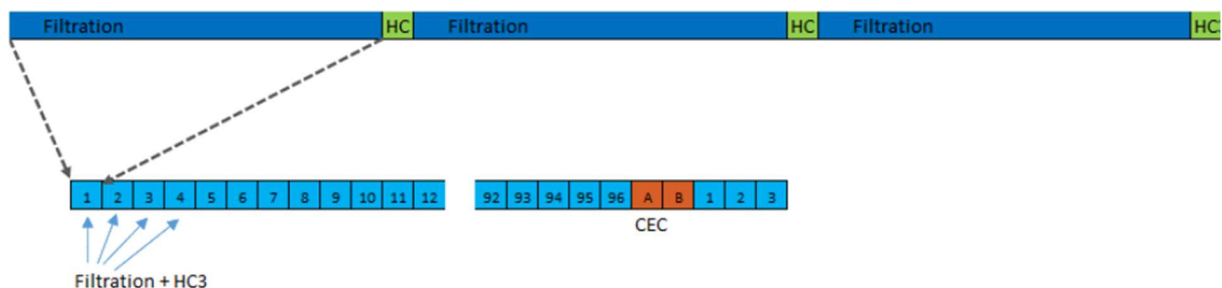

Figure 60. Diagram of filtration cycles with hydraulic (HC) and chemical (CEC) cleaning.

The RO pilot plant, with a treatment capacity up to 4 m³/h, is provided by Aqualia, fully equipped, consisting of a frame that houses an electrical panel, 2 RO spiral membrane

in series, as well as the necessary peripherals (feeding pump, low-pressure pump, high-pressure pump, pre-filter, 2 dosing pumps and dosing anti-scaling and disinfectant) and 1 buffer tank. There is a continuous monitoring of conductivity, pH, flow and several rotameters and manometers. The dimensions are 4,5m x 1,4m x 2,1m (LxWxH).

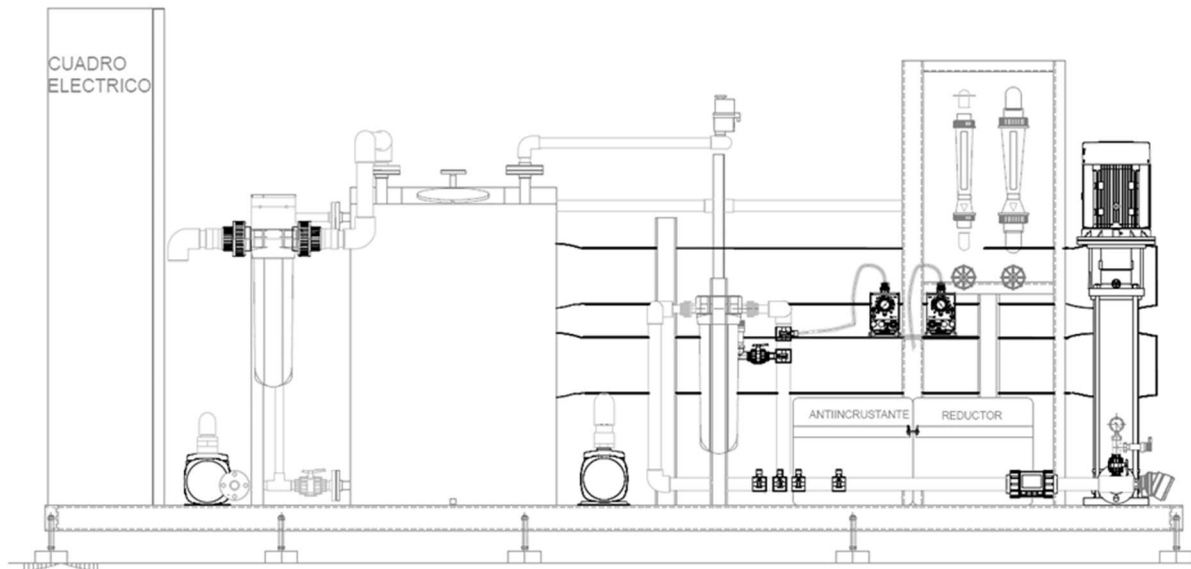

Figure 61. Drawing of the RO pilot plant used for CS5 water reclamation case.

A weekly sample is taken for inlet water, after NF, after RO and, when available, remineralized water. Analytical determinations were driven by an external lab.

The AOP+UV experiment was done in tests in a lab-scale plant owned by Aqualia with distilled water (at 18L/min) using specific micropollutant concentrations. The aim was to determine the configuration that drives to a maximum concentration removal. Specifically, the degradation of 10 ppm of diclofenac (DCF) has been studied, considering that diclofenac is one of the most studied micropollutants in waters, with average contents of 65 ng/L in surface waters and 647 ng/L in WWTP effluents [4]. A Spanish technological spin-off was the responsible for the design, manufacture and supply of ceramic supported photocatalysts (CSP), which are produced through innovative 3D-printing technologies. Aqualia installed this structures that fit to existing commercial UV lamps. I.e. this solution could serve as an upgrading / retrofitting of existing UV disinfection steps, adding a AOP process to the existing disinfection process.

Firstly, a thermoplastic structure was sent to Aqualia to confirm that the geometry fits to the existing plant (Figure 62). Once done, the supplier of the CSP impregnated the structures with the material with photocatalytic activity, did some tests and selected the best two to Aqualia for run in lab-plant, where the real degradation rate could be measured.

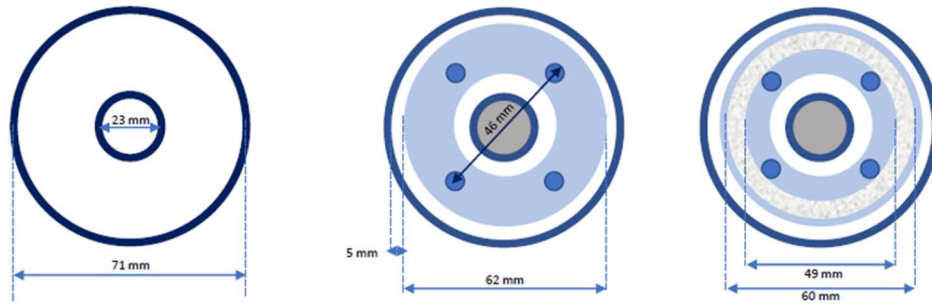

Figure 62. Top: photocatalytic reactor with support and first (white) PLA prototypes. Bottom: three sections of the UV lamp, where toroidal structures can be inserted.

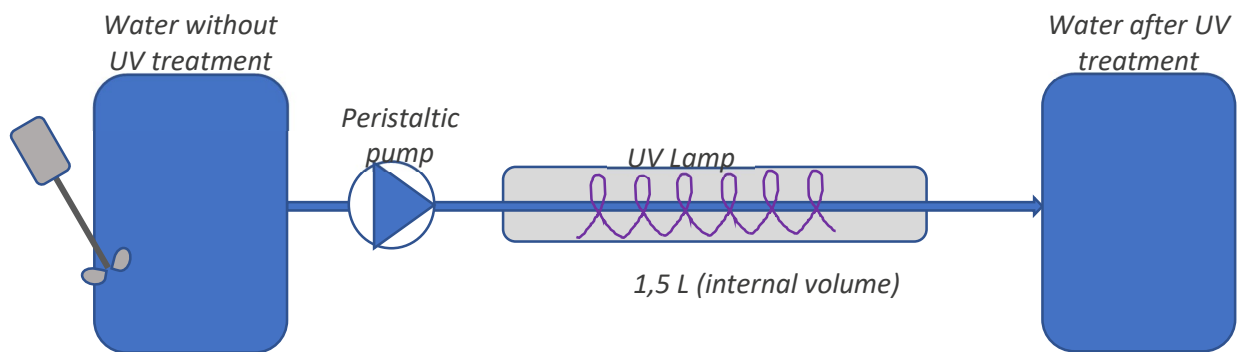

Figure 63. Diagram of the lab-scale UV+AOP plant.

2.5.2.2. Energy recovery technological solution

Anaerobic Membrane Reactor (AnMBR)

AnMBR technology combines the advantages from both anaerobic digestion processes and ultrafiltration membrane systems:

1. Conversion of the organic matter present in the influent wastewater into a biogas stream, mostly composed of methane and carbon dioxide.
2. Low sludge production because of the low yield of anaerobic microorganisms, generating less residues and emissions.
3. Low energy consumption because no aeration is required. In addition, bioenergy as heat and electricity can be harvested from the biogas.
4. High quality of the effluent, as membrane ultrafiltration completely retains the microorganisms within the anaerobic reactor.

- Decoupling of both hydraulic retention time (HRT) and solids retention time (SRT) and therefore possibility to work under low temperatures by increasing SRT.

A pilot scale AnMBR reactor has been designed and built, with a reactor volume of 4 m³) and 2 units of membranes (14 m² of filtration surface each). It will have a capacity of treating 2 m³ of wastewater/hour or 200 kg COD/d, with an expected biogas production of ca. 3,1 Nm³/h.

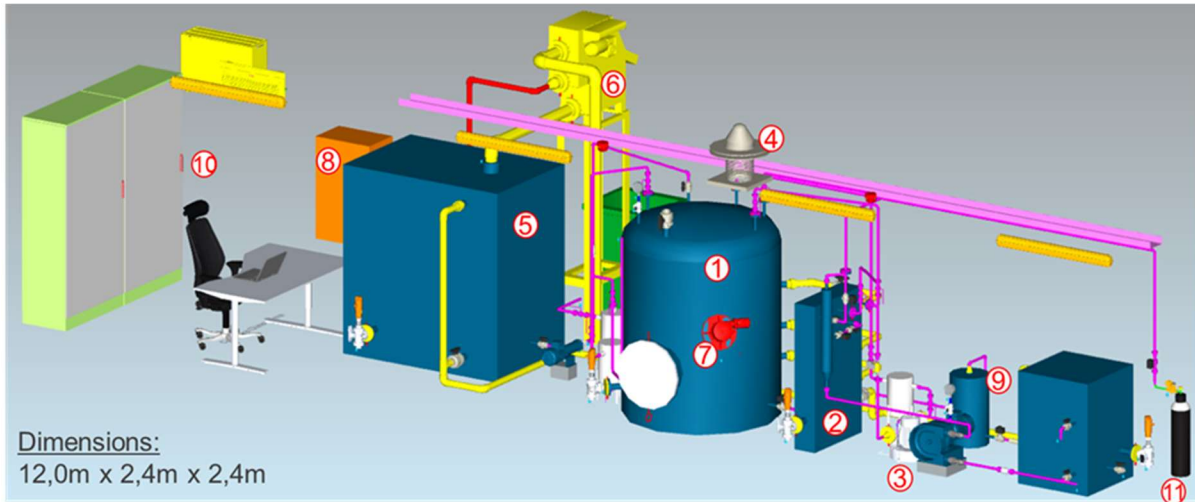

Figure 64. 3D drawing of the AnMBR. 1) Biological reactor 2) Membranes 3) Blower and recirculation pumps 4) Ventilator 5) Buffer tank 6) Screen 7) Stirrer 8) Electrical cabinet 9) Backwash and permeate tanks 10) Office 11) Inert gas.

The pilot plant was assembled in the interior of a 40 feet maritime container (12.2 x 2.4 x 2.9 m). As similar to the SOFC pilot plant (also contenerized), an excess air ventilation strategy will declassify the explosive atmosphere, as well as two Lower explosive limit (LEL) detectors will be installed.

Wastewater is collected and pumped (P1) to an equalization tank (T3000). Solid particles bigger than 2 mm are retained in a rotatory sieve before entering the storage tank. Then, wastewater is pumped (P3) to the anaerobic bioreactor (DA 3000). This tank is hydraulically connected with the membrane tank, where the submerged membranes are located, and the ultrafiltration process takes place: the sludge is separated from the treated water by pumping (P4) the latter through the pores of the membranes. The effluent is stored in a clean-in-place (CIP) tank (T-500) and used for the backwashing of the membranes following a cleaning procedure.

Table 27. Characteristics of the membrane module.

Characteristic	Value
Membrane material	PVDF
Membrane fiber ID/OD (mm)	1.0/2.0
Membrane area (m ²)	14



Characteristic	Value
Nominal pore size (μm)	0.02
Membrane type	Immersed
Membrane configuration	Hollow fiber outside-in
Max. Extraction pressure (- bar)	0.6
Max. Backwash pressure (bar)	0.3
Max. Water temperature ($^{\circ}\text{C}$)	40
pH resistant range	1~13
Dry weight (kg)	16
Dimension (L×W×H) mm	721×70×1.082

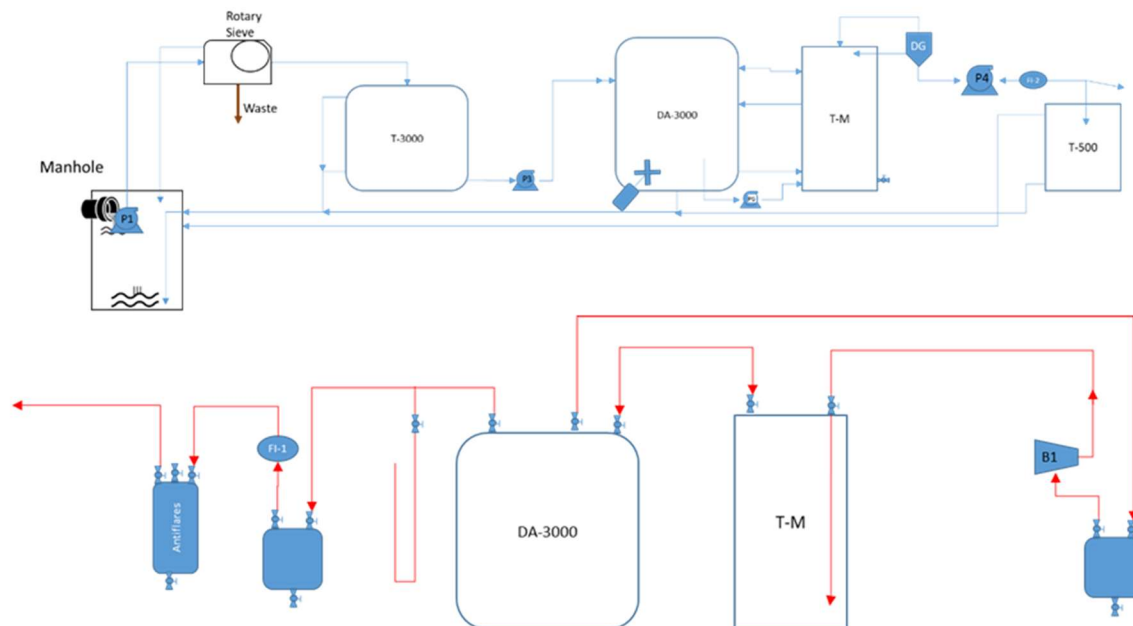

Figure 65. Water (top) and biogas (bottom) flow diagram of the AnMBR process.

In order to improve the stirring conditions of the AD reactor, the sludge is internally recycled back to the reactor from the membrane tank. Additionally, a fraction of the biogas produced is injected into the membrane tank through a set of coarse bubble diffusers placed at the bottom of the membrane modules, to minimise cake layer formation. This strategy also favours the stripping of the produced gases from the liquid phase. With the aim of recovering the biogas bubbles extracted with the membrane effluent, a degassing vessel (DG) is installed between the membrane tank and the CIP tank.

A process control philosophy was developed to establish guidelines to PLC and SCADA programming. The plant control includes several lower layer control loops





which consist of several classical PID and on – off controllers that are programmed to control the main operating variables, such as: flow-rates (influent, permeate, sludge recycling and wasting, and recycled biogas through membrane tank); biogas pressure in the system; blower output pressure; transmembrane pressure; reactor temperature; and mixed liquor level. Also, process control philosophy includes several security conditions and alarms to guarantee the correct operating of the plant and the protection of equipment.

ELSAR®

ELSAR® (ElectroStimulated Anaerobic Reactor) searches the excellence in anaerobic high-rate anaerobic reactors (HRAR), by improving effectiveness (biogas productivity, nutrient and COD removal), efficiency (biohydrogen productivity, self-sufficiency), compactness and biomass resilience. Previous experiences showed better performance and much robustness of ELSAR® vs. HRAR [2].

ELSAR® shares with conventional high-rate anaerobic reactors (HRAR) the use of a fluidized granular sludge bed operated in the mesophilic range [12]. This represents a strategy for better settling properties and high concentration of biomass. Inoculum can be brought from existing HRAR.

A comprehensive sampling and analytical determination of the wastewater has been conducted in July 2020. Additionally, Aqualia has available the average COD contents, electrical conductivity and pH of the wastewater.

Table 28. Characterization of the brewery wastewater in July 2020. Based on 28 24h-integrated samples.

PARAMETER	AVERAGE ± STANDARD DEVIATION	UNITS
COD (stirred sample)	5586±1732	mg/L
COD (settled sample)	4674±1765	mg/L
NH4	3±3	mg/L
NO3	2±1	mg/L
Total N	64±23	mg/L
Total P	17±4	mg/L
Sulphates	158±32	mg/L
Sulphur	<1	mg/L
Conductivity	2551±627	µS/cm
Total alkalinity	19,3±6,6	meq/L
Partial alkalinity	8,8±4,4	meq/L
Intermediate alkalinity	12,9±3	meq/L
Volatile fatty acids	15±3,6	mg Ac/L
pH	6,67±0,96	-log[H ⁺]





PARAMETER	AVERAGE ± STANDARD DEVIATION	UNITS
Total suspended solids	199±99	mg/L
Volatile suspended solids	124±51	mg/L
% VSS	0,67±0,16	%
Settled solids	40±30	mg/L

To assess the anaerobic biodegradability, a standard biochemical methane potential (BMP) test was conducted by Aqualia ending 2020. A potential of 0,31 Nm³ CH₄/ removed kg COD was obtained (Figure 66). This result is consistent with other sources for similar wastewater.

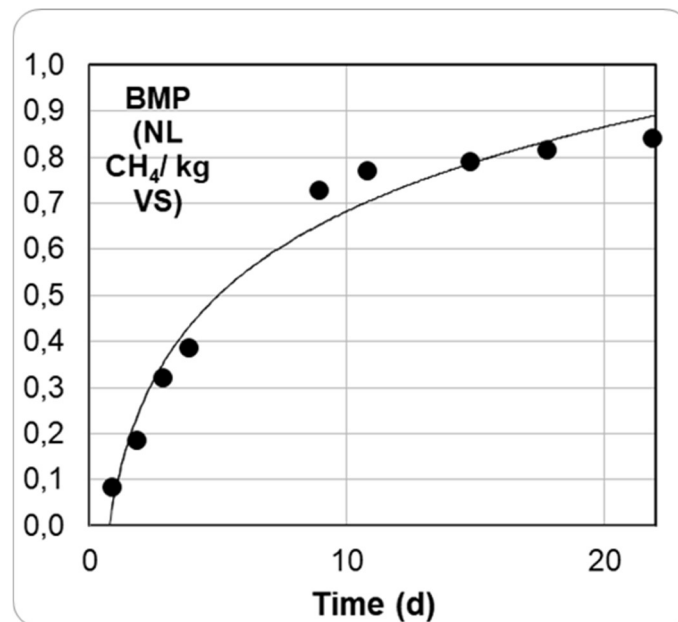

Figure 66. Methane production evolution in the Biochemical methane potential (BMP) conducted using brewery wastewater.

As an anaerobic solution, a biogas line is required, including flowmeter, gasometer, boiler and torch. The boiler burns the generated biogas for providing the required heat of the system for maintaining the mesophilic range. An electrical small boiler is also included for periods of time when there is no biogas available (for instance, commissioning, not enough loading rate or maintenance tasks of the boiler). The reactor itself is isolated for a better heat use. The produced biogas (estimated in 31 Nm³/h, ca. 200 kW) provides energy enough for the required heat, which means that the solution is fully self-sufficient, from a calorific point of view. Gasometer and torch are isolated in a specific ATEX zone and protected from vehicular collisions with mobile concrete barriers.

The wastewater is sent to a buffer tank where the water is adjusted to the optimum conditions (temperature, pH, redox...) for the electrogenic biomass. The ELSAR® will be able to treat 20 m³/h of wastewater (or an organic loading of 2000 kg COD/h) with possibilities of eventual hydraulic peaks up to 27 m³/h. A 95% of removal performance in terms of COD is expected. A recirculation pump provides the required upflow velocity



for fluidization of the sludge bed in the reactor. Several reactions are expected to happen in the vertical axes of the ELSAR®, and they are described as follows.

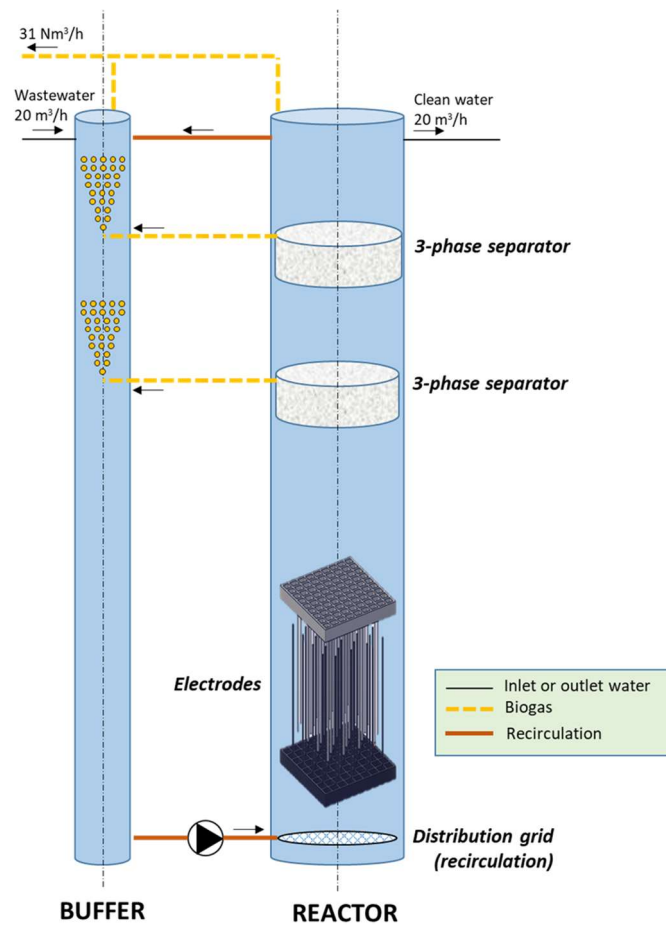

Figure 67. Schematic overview of pre-commercial size ELSAR®.

In the bottom of the reactor, the conditioned water enters to the reactor, providing enough water turbulence and enough fluidization of the anode, composed basically by activated carbon. This activated carbon transfers the accumulated electrons to a fixed anodic collector through continuous collision.

Then the water enters to the granular biomass zone, combined with anodic and cathodic collectors at galvanostatic regime. In this zone the main biological reactions take place, like methanogenesis, but also other electrochemical reactions, like hydrogen production by electrolysis, taking profit of the electron transfer happened in the bottom of the reactor.

In the next height level, there is a double three-phase separation system that allows the maximum separation of the three phases: solid (granular sludge, by sedimentation), liquid (treated effluent) and gas (biogas, by accumulation and upper collection). Finally, in the top of the reactor, the treated water flows to discharge. Prior to discharge, the treated wastewater enters in a heat exchanger, providing the residual heat to the inlet wastewater, in order to increase the energetic efficiency and minimize the risk of lack of heat autarchy, especially in cold / winter times.

Due to this vertical approach, the resulting reactor is very high (15 m) and slim (diameter 3.5 m), with a water volume of ca. 143 m³. The buffer tank is even slimmer, with the same height and only 1.5 m diameter. These heights require:

- A levelled concreted deck for each one of the tanks, as well as for other biogas equipment (gasometer and torch).
- Foundation, due to the pressure of the water column, as well as the weight of the tanks. Micropiles are needed below the deck of both vertical tanks
- Metallic structure to access (with stairs, platforms and stair rails) to the upper levels of the tanks. This structure will also provide support as wind protection.

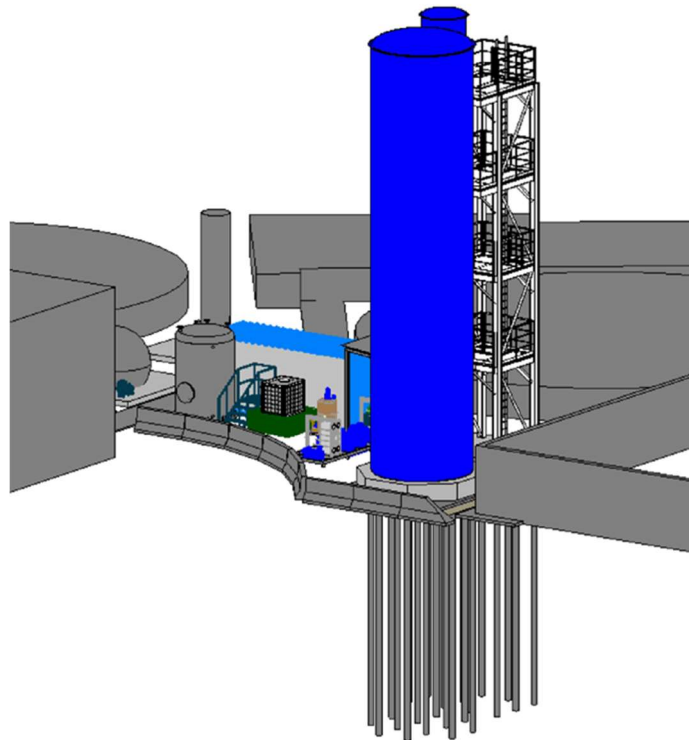

Figure 68. 3D overview of the precommercial size ELSAR®. Micropiles, concrete deck and metallic structure on both vertical tanks can be seen. Mobile concrete barriers to protect vehicular collision can also be seen.

Due to the delays in the pre-commercial ELSAR®, a pilot ELSAR® has been run with brewery wastewater, aiming the validation of processes and structures. The pilot plant contains all the needed elements for simulate in a pilot-scale the same process than in the big-scale, although some processes (like biogas treatment) are inexistent.



Figure 69. Picture of the ELSAR® pilot plant.

Solid Oxide Fuel Cell (SOFC)

The low conversion efficiency of conventional energy conversion devices like internal combustion (IC) engines and turbines in traditional CHP solutions in WWTP, prevents biogas from reaching its full potential as over 50% of chemical energy is dissipated [16]. Generally, SOFC efficiency is much higher than IC engines (especially for the small ones) and the presence of CO₂ in biogas is helpful for internal methane reforming. Hence, IC engines can be potentially replaced with SOFC in WWT plants.

The application of biogas as a fuel to high efficiency energy conversion devices like fuel cells, especially Solid Oxide Fuel Cell (SOFC) has been reported for stationary applications. SOFCs are modular, silent, low-emission and vibration free devices that generate electrical power by electrochemical reactions [10]. Moreover, the high-temperature operation gives an opportunity to use the heat for co-generation or bottoming cycles and enables high exergy efficiencies [17]. Finally, the technology is modular and doesn't emit NO_x, SO_x or particles to the atmosphere.

A domestic-scale SOFC has been chosen for the pilot plant. Prior to this plant, a whole pre-treatment must be present, since the biogas that feeds the SOFC must accomplish the following requirements:

- Continuous mode. Since high temperatures occur inside the SOFC for the needed reforming, the SOFC should minimize the stops or shutdowns, which can happen under three circumstances: electrical grid shortage, interruptions in biogas or water or fan incidence or inactivity (since without fan there is a risk of explosion).
 - Uninterruptible Power Supply is installed for eventual grid shutdowns
 - All the elements are isolable and 1+1 configuration (one line in operation, the other one inactive) is preferred, to minimize biogas interruptions.
 - For cases of pre-treatment incidents / interruptions, synthetic biogas (with the same composition of the raw biogas) will feed the SOFC.



- < 20ppmv H₂S. The annual average H₂S content in the raw biogas is ca. 75±15 ppmv.
 - Adsorption of H₂S through conventional filters has been chosen as pre-treatment.
- Free of siloxanes and volatile organic compounds (VOC). These compounds may harm the cells. Siloxanes in the raw biogas are ca. < 10 mg/m³.
 - Adsorption of siloxanes and VOC through conventional activated carbon filters has been chosen as pre-treatment.
- Min / Max pressure: 15 / 25 mbar
- Rather no humidity, or, at least, no water-vapour condensation
 - Cooling of biogas (up to 5°C) for water condensation and then absorption of water through conventional zeolite filtering has been chosen as pre-treatment.

The SOFC and all the pre-treatments will be installed in a 20-feet container. This converts the inside of the container in a possible ATEX zone. To avoid this risk, a fan in continuous mode will declassify the zone. Additionally, 2 units of lower explosive limit (LEL) detector for CH₄ leaks and an alarm are all inside the container. Bidirectional flame arresters are installed in end biogas pipes.

Solid-oxide fuel cell demo plant.

Composed by:

1. Fuel Cell
2. Vacuum pumps
3. Desulphuration filters
4. Heat exchanger
5. Chiller
6. Dehumidification filters
7. Activated carbon filters
8. Pressure pump
9. Emergency biogas supply
10. Nitrogen gas
11. Electrical cabinet / PC

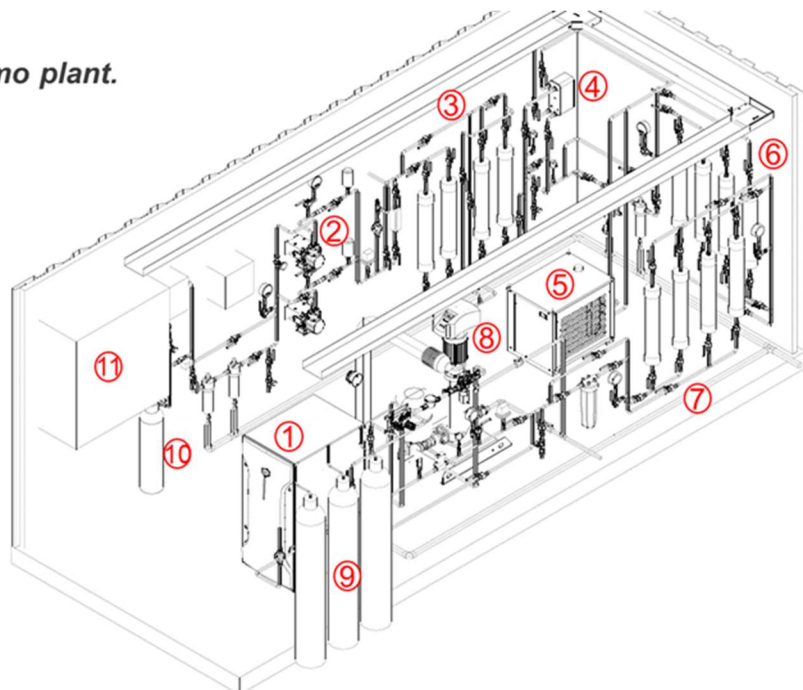

Figure 70. 3D drawing of the SOFC pilot plant.





Figure 71. Pictures of the side (left) and entrance (right) of the (bio) fuel cell pilot plant.

2.5.2.3. Nutrient recovery technological solution

ThermoSolar-based device

The following questions motivate the development of a solar-based thermal solution applied to sludge treatment.

- New possible regulatory scenario, stricter in terms of sanitation, also for compost.
- Adaptation to regulations in some communities on sludge sanitization.
- Need of maximize biogas productivity with pre-treatments of sludge like hydrolysis.
- Increase dry matter in sludge for minimize transport cost for external management.
- Reduce carbon footprint in sludge and water treatment.

The objective is to test hydrolysis, sanitation, drying and pre-heating for subsequent solar carbonization. In this case, it is a development for the "proof of concept", where what is desired is to validate a process or approach, not so much a technological validation of the solution itself. Regarding treatment capacities:

- Drying 6 kg sludge/d
- Hydrolysis 12 kg sludge/d
- Sanitation 24 kg sludge/d

As it is well known, the Iberian Peninsula is one of most sun-exposed European regions, with average direct normal irradiation of ca. 2000 kWh/m². Sun is a renewable, easily available and free resource.

There are already commercial solutions around the use of solar energy on sludge treatment. The most common use is the low temperature extensive solutions for sludge drying. They can be with or without a transparent cover that not only protects the sludge bed from rain, condensation or wind, but also accumulates the heat from the sun. However, no matter the development, the temperatures are not high enough (>55°C)



to meet the sanitation of sludge. Moreover, the dry process takes weeks, which require big extensions for drying sludge.

In the other site there is already know-how about how to take profit from the sunlight. Ca. half of the thermosolar developments for energetic uses is located in Spain. Thermosolar developments are based on concentration of sun radiation, achieving temperatures up to 1000°C, usually heating fluids like water, oil or molten salts. However, these solutions require auxiliar equipment like heat exchange, boilers instrumentation, and infrastructure, adding more complexity and more costs to the solution.

By using concentrated sunlight directly focused on sludge, higher temperatures (>55° C) could be achieved, decreasing dramatically the exposure / retention time compared to extensive systems, warranting safe sanitation temperatures. Based on direct irradiation of sludge, there would be no need for steam, auxiliary boiler and heat exchanger, or greenhouse-type infrastructures.

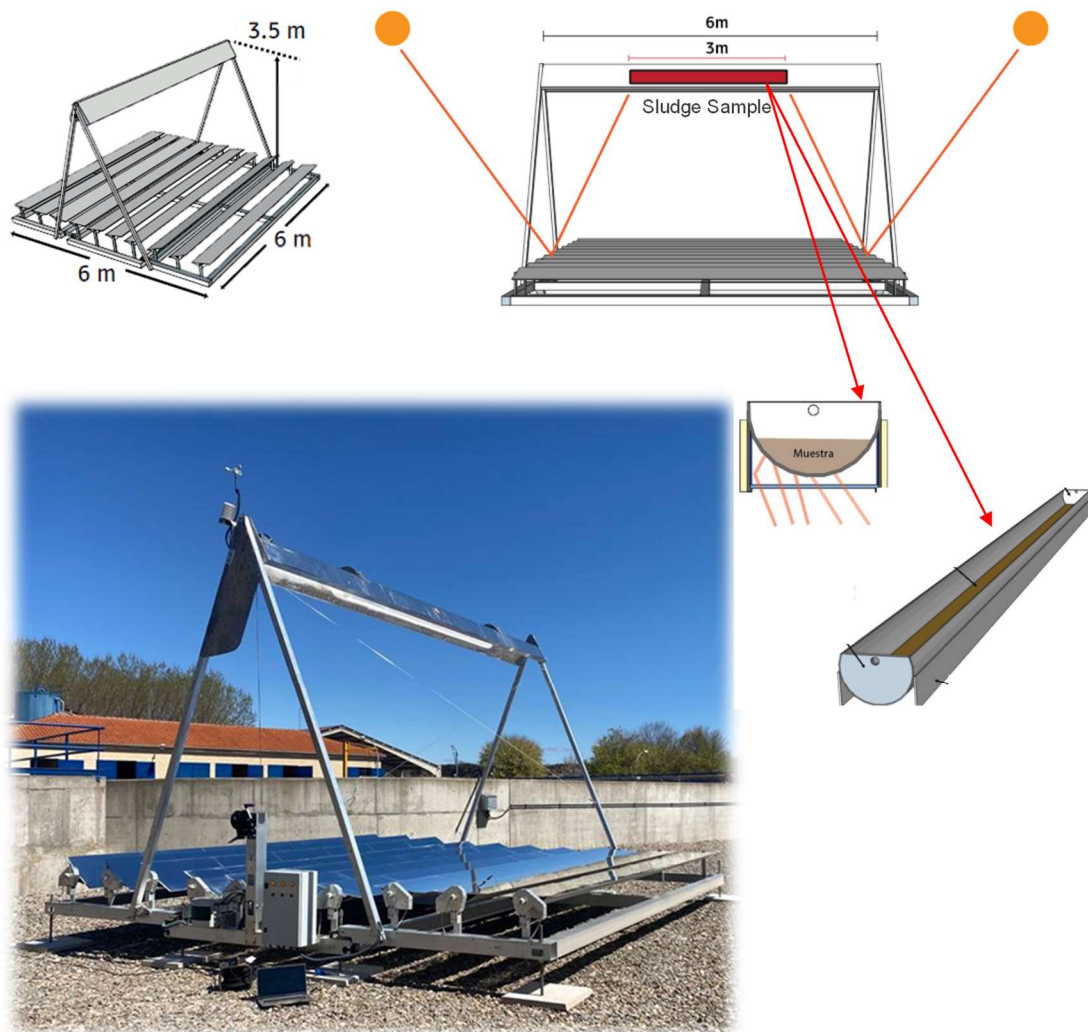

Figure 72. Top, left: 3D view of the sun module. Top, right: front view. Bottom, left: picture of the solar-based pilot plant in the WWTP. Bottom, right: Detail of the receptacle where lays the sludge bed.

The module is based on Fresnel-type lens, which are self-orientable, maximizing sunlight capture. The nominal power of the module is 14,5 kWt, considering 900 W/m² and average local conditions. A vessel or receptacle has been specifically designed, built and incorporated to the module for the CS5 trials. Two temperature transmitters were put below the secondary reflector, to measure temperature in the sludge bed. On the top, there is a measuring station for humidity, wind, and solar irradiation.

The plant is designed for batch tests. A worker can access to the vessel and fill it with sludge or compost. Then the receptacle can be lifted and the mirrors can be changed to the operation mode position.

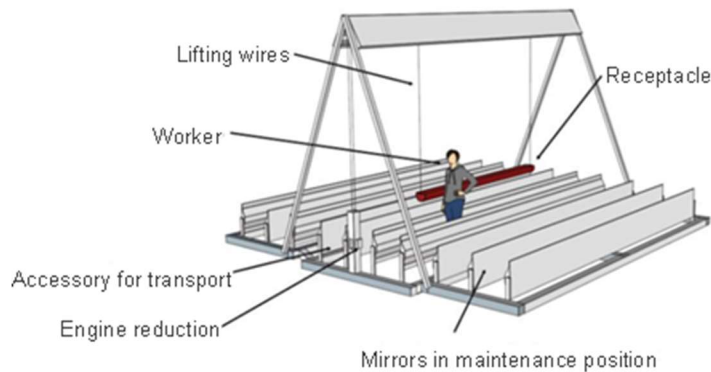

Figure 73. 3D drawing of the module in maintenance mode.

Objective in sanitation is to meet the requirements of the 4th draft of EU 86/278/CEE.

Table 29. Sanitation requirements on the 4th draft of EU 86/278/CEE.

	Escherichia coli, CFU/g DM	Salmonella, Presence in 50g	Clostridium perfringens, CFU/g DM
Draft EU 86/278/CEE	< 10 ³	NO	< 3·10 ³

2.5.3. Start-up operation

2.5.3.1. Water reclamation pilot plant start-up operation

Several actions were driven for the nanofiltration and reverse osmosis units start-up: check position pilot container, check hydraulic connections for feed / permeate / waste streams and tighten them and assure not leaks, clean pre-filters, check electrical connections, control system, sensor signals and internet, fill raw water tank with tap water and chemical storage tanks with chemicals: HCl, NaOH and NaOCl, etc.

2.5.3.2. Energy recovery pilot plant start-up operation

Anaerobic Membrane Reactor (AnMBR)

The installation of the pilot plant is completed, as well as the connection to the sewer system, and the 3G-connection for remote control. The process control philosophy has been successfully finished and hydraulic tests have been concluded. In other words, “cold” start-up (i.e. checking of equipment and instrumentation, with tap water or compressed air) is finished.



Significant delays happened due to the safety inspections, like the ones reported in the SOFC plant, but also to specific components (Variable Frequency Drive) that required an extended time to be set up.

Seeding the reactor with anaerobic sludge will be done in December 2022.

ELSAR

ELSAR® pilot was already in operating condition before arriving to the Mahou San Miguel brewery, thus start-up only refer to confirm basics, like check of the feed and discharge connections, check electrical connection, check of absence of leaking, etc.

Solid Oxide Fuel Cell (SOFC)

First tests on the SOFC plant were already driven in the assembling step. Before shipping to destination, the tightness was tested by putting compressed air (up to 2 bar where possible) and then proof there was no leakage after 24 hours. All the installed equipment followed the quality inspection point for reception and for installation.

Once in the location, all the connections (biogas feed, tap water, compressed air, power and communication) where built and checked.

Then the “cold” start-up has been done, i.e., the different elements of the SOFC pilot plant (except the SOFC itself, which can only be installed and tested when the biogas and the water supply are ready) were checked and tested. In other words, the process control philosophy (PCP) of the pilot plant has been checked with air (instead of biogas).

Afterwards, two safety inspections were conducted: one related to explosion protection document, the second one to other regulations related to explosive / flammable gases. The regulations to be applied were:

- R. D. 919/2006 flammable gases. Family of mandatory standards. UNE EN 60670 Installations for a pressure maximum operation <5 bar.
- ITC-BT-29 Particular prescriptions for Electrical Installations of Premises with risk of fire or explosion.
- UNE EN 60079-14 Design, choice and realization of electrical installations.
- UNE EN 60079-17 Explosive atmospheres, inspection and maintenance of electrical installations.
- R.D. 681/2003 of July 12, on the protection of the health and safety of workers exposed to the risks derived from explosive atmospheres in the workplace.
- R.D. 144/2016, of April 8, which establishes the essential health and safety requirements required of equipment and protection systems for use in potentially explosive atmospheres.

These inspections brought compulsory modifications in the plant which were done in the last trimester of 2022.

Afterwards first results were conducted with biogas to validate the pre-treatment of biogas, i.e. without SOFC activity, and to validate the sampling procedure (results pending).

The analytical plan in the SOFC will be:





- Monthly (certified) analytical determination of biogas components (before entering the SOFC).
- Weekly (non-certified) analytical determination of biogas components (before entering the SOFC), as control routine.
- Online measuring of pressure, temperature and moisture before entering the SOFC.
- Register of incidences, biogas consumption, produced energy, electrical energy consumption and water consumption
- External 24h-monitoring of the SOFC and technical support for the 1st year of operation.

The final SOFC start-up procedures are expected to finish in December 2022.

2.5.3.3. Nutrients recovery pilot plant start-up operation

ThermoSolar-based device

For each test, the following procedures have been followed:

- Check climatic conditions and forecast.
- Registering of the sample: date of batch test, type (sludge, compost), origin, time of high temperature exposure.
- Filling of receptacle and lifting up. Registering of time of lifting up.
- Register temperature of the sludge bed and the measured radiation. Check that temperature is increasing (this will indicate the temperature transmitters are well inserted). Once arrived to 80°C, it is considered the batch has started.
- Register of temperature of the sludge bed and the measured radiation, and take samples, according to the following table. Sample tool is disinfected with ignition after each sample and then cooled down to non-inhibitory/ambient temperatures.

Table 30. Analytical programme for each trial for dewatered and thickened sludge. For compost, sampling was done only for 0, 10 and 120 minutes. Except for sample "0", the time in minutes or hours refers to the time after the objective temperature has been reached (e.g., 80°C).

Sample	MinutEs	Time	Dry Matter	Volatile Matter	pH	<i>E. Coli</i>	<i>C. perfringens</i>	<i>Salmonella spp.</i>
0	0	0	x	x	x	x	x	x
1	10	0,167	x	x		x	x	x
2	30	0,5	x	x		x	x	x
3	60	1	x	x				
4	180	3	x	x	x			
5	300	5	x	x				
6	420	7	x	x	x			





2.5.4. Results from pilot plant operation and discussion

2.5.4.1. Water reclamation pilot plant results

From a quality point of view, as in the previous lab-tests, the obtained NF and RO treated wastewater met, without exception, all the legal requirements for water reuse (Table 31). Total retention of suspended matter, dissolved organic matter, microorganisms and turbidity was observed. Salinity retention is satisfactory, even when the plant has operated at high pressure.

Table 31. Average data \pm standard deviation between February and September 2022 of the currents of the different stages of the regeneration test at Mahou San Miguel. Highlighted in green and orange, the parameters that meet or fail, respectively, the reuse requirements.

Parameter	Input water	NF permeate	RO permeate	Remineralized	Limit	Regulation
<i>Legionella</i> sp (CFU/L)	NA	NA	NA	Absence 7/10 (see above)*	NA	RD 1620/2007
Nematode eggs (u. /10L)	NA	NA	NA	NA	1	RD 1620/2007
<i>E. Coli</i> (CFU/100mL)	114560 \pm 225850	NA	NA	NA	NA	RD 1620/2007
Total Suspended Solids (mg/L)	32 \pm 17	<3	<3	<3	5	RD 1620/2007
Turbidity (UNF)	7.8 \pm 4.1	<0.4	<0.4	<0.4	1	RD 1620/2007
pH	8.3 \pm 0.2	8.4 \pm 0.1	6.6 \pm 54185.2	7.3 \pm 0.4	6.5 - 9	RD 865/2003
Electrical conductivity (μ S/cm)	2866 \pm 281	2812 \pm 302	49 \pm 56	126 \pm 83	400 (ideal <250)	Customer needs
BOD5 (mg/L)	18 \pm 18	< 2	< 2	< 2	-	-
COD (mg/L)	113 \pm 35	32 \pm 12	< 5	< 5	-	-
Chlorides (mg/L)	-	-	1.57 \pm 2.17	5.73 \pm 4.01	125	IDEA
Alkalinity (mg/L)	-	-	<20	50.22 \pm 26.2	500	IDEA
Hardness (mg CaCO ₃ /L)	-	-	< 4	24.75 \pm 24.89	60 - 500	IDEA
Langelier index	-	-	-3.3 \pm 0.6	-1.8 \pm 0.9	-0.5 - 0.5*	RD 865/2003
Total Fe (μ g/L)	-	104	12.3 \pm 19.8	73.25 \pm 168.11	2000	RD 865/2003
No. of samples	25	25	24	9		



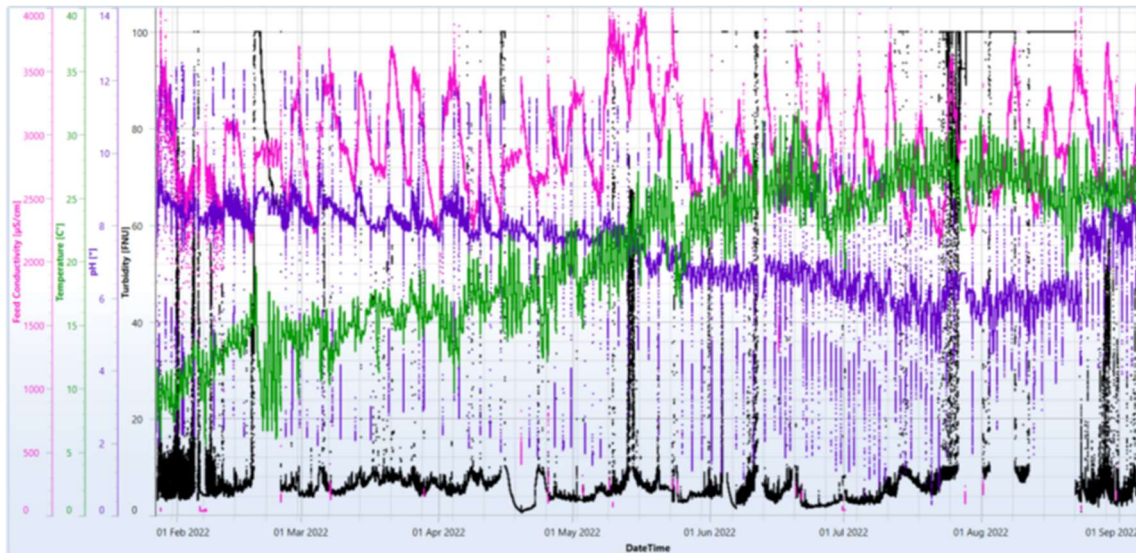

Figure 74. Turbidity [FTU, black], Temperature [°C, green], pH [-, purple] and Feed conductivity [µS/cm, pink] evolution in the inlet treated wastewater between February and August 2022.

The NF technology has tolerated the oscillations of the water (previous chart) well and presents a stable process in terms of membrane fouling. It has been possible to run the plant with flux of 25 L/m²/h, with the minimum speed in crossflow velocity (0,2m/s) and with a recovery of 75%. These settings are generally above the supplier's expectations. Above this value, the permeability decreases (see week 27-28 in the next figure), which indicates excessive fouling of the membranes. It is likely that the increasing temperature from February to September has positively influenced the trial.

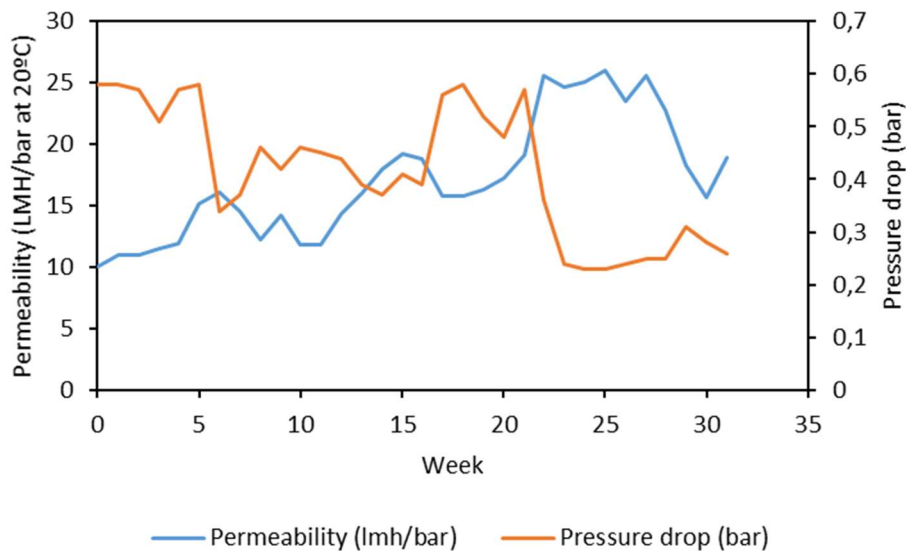

Figure 75. Weekly evolution of average permeability and average pressure drop.

A more detailed evolution of the operation parameters can be observed in the next chart.



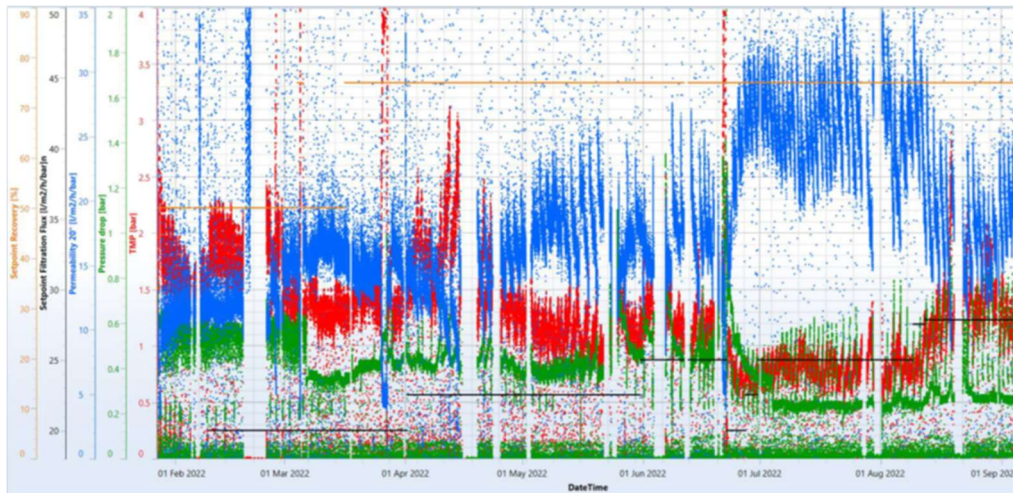

Figure 76. Evolution of recovery, flow, permeability, pressure difference (pressure increase due to accumulation of solids (clogging)) and transmembrane pressure (red) between February and August 2022 in the nanofiltration pilot plant.

Despite the good evolution in the NF, the fluctuations in suspended matter (TSS) in the inlet water may be excessive, due to eventual punctual accumulation of sludge at the suction point. This question should be considered in a further real design, where the aspiration will be defined in such a manner that the aspiration of such TSS accumulation is minimized.

Additionally, there have been episodes of biofouling growth in deposits with high retention times and low velocities, both upstream and downstream of the NF. To avoid this undesired growth, the stored water tanks must be opaque and in a real plant a disinfection system must be included with some non-chlorinated agent (eg sodium metabisulphite).

For remineralization, a reject current generated in the RO used by Mahou SM in purification was used, which was mixed with the water obtained by the pilot in a 4 m³ capacity tank. The objective was to obtain a water free of corrosion and at the same time to know the mixing needs. It can be seen in the table above that all the legal requirements regarding water reuse are met. However, *Legionella* was detected in this tank on 3 occasions (out of 10 samples), which is attributed to inadequate storage conditions, since the tank was exposed to the sun without the possibility of refrigerating or covering it and since there was no detection in the produced RO stream. After the detection of this microorganism, a continuous dosing of reagent based on free chlorine is carried out, which solved the situation.



Table 32. Summary of average operational results obtained in various configurations tested in the NF plant: permeability (corrected at 20°C), pressure difference (pressure increase due to accumulation of solids (clogging), temperature of the water to be treated and conductivity of the water to treat.

Trial week	Date		Permeability	Pressure drop	Temperature	Feed Conductivity
			[lmh/bar]	[bar]	[°C]	[µS/cm]
0	24-Jan	30-Jan	10	0.58	9.2	3199
1	31-Jan	6-Feb	11	0.58	10.5	2734
2	7-Feb	13-Feb	11.0	0.57	11.6	2858
3	14-Feb	20-Feb	11.5	0.51	14.8	2645
4	21-Feb	27-Feb	11.9	0.57	14.7	3045
5	28-Feb	6-Mar	15.2	0.58	15	2962
6	7-Mar	13-Mar	16.1	0.34	14.5	3201
7	14-Mar	20-Mar	14.5	0.37	16.1	3227
8	21-Mar	27-Mar	12.2	0.46	16.7	3241
9	28-Mar	3-Apr	14.2	0.42	15.7	2922
10	4-Apr	10-Apr	11.8	0.46	15.2	2993
11	11-Apr	17-Apr	11.8	0.45	17.3	2845
12	18-Apr	24-Apr	14.3	0.44	17.8	2956
13	25-Apr	1-May	16.0	0.39	19.1	3113
14	2-May	8-May	18.0	0.37	21.6	3094
15	9-May	15-May	19.2	0.41	21.2	3612
16	16-May	22-May	18.8	0.39	23.9	3382
17	23-May	29-May	15.8	0.56	23.2	2921
18	23-May	29-May	15.8	0.58	23.5	2993
19	6-Jun	12-Jun	16.3	0.52	24.5	2990
20	13-Jun	19-Jun	17.2	0.48	25.7	3001
21	20-Jun	26-Jun	19.1	0.57	24.9	3159
22	27-Jun	3-Jul	25.6	0.36	23.7	2808
23	4-Jul	10-Jul	24.6	0.24	25.0	2983
24	11-Jul	17-Jul	25.1	0.23	27.0	2820
25	18-Jul	24-Jul	26.0	0.23	27.3	2550
26	25-Jul	31-Jul	23.5	0.24	27.3	2790
27	1-Aug	7-Aug	25.6	0.25	27.4	2730
28	8-Aug	14-Aug	22.8	0.25	27.5	2785
29	15-Aug	21-Aug	18.3	0.31	25.4	3063
30	22-Aug	28-Aug	15.7	0.28	25.3	2948
31	29-Aug	4/Sep	18.9	0.26	25.0	3059

Further simulation showed that there is a risk of calcium and iron scaling. This forces to include -in a hypothetical upscaling- a chemical dosing for minimizing (see chart below, with and without treatment). This effect has been difficult to be observed in the trials, especially because membranes recovered well after acid cleaning treatment.



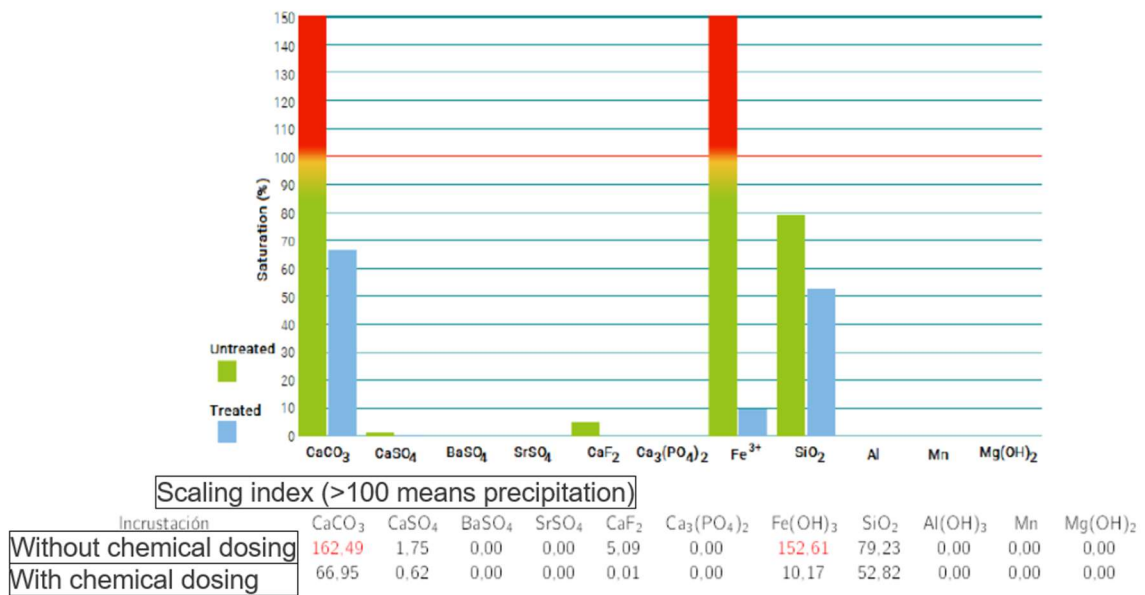

Figure 77. Scaling risks considering the average mineral content on treated water.

Regarding to the UV+AOP process, different geometries, and materials of ceramic supported photocatalysts (CSP) were tested. The best geometry shall be the one that achieves best diclofenac degradation rates, that allows good fluid dynamics of contaminated water and that doesn't compromise structural stability.

Some challenges have been observed during the design and test, like the importance of minimize the shadow produced by the CSP (i.e. increase as maximum as it is possible the open porosity (in size and quantity), to achieve maximum exposure of the photoactive phase embedded in the thermoplastic matrix), the importance of avoiding the re-precipitation of the tested emerging pollutants and the difficult to produce structures that can resist the normal conditions of a disinfection treatment (vibration, friction, turbulent regimes, etc).



Figure 78. Some thermoplastic particles and dust were observed after first Aqualia's tests, proving that resistance of the structure had to be improved, although the reasons of these damages were not fully understood. Samples were sent to the CSP supplier.

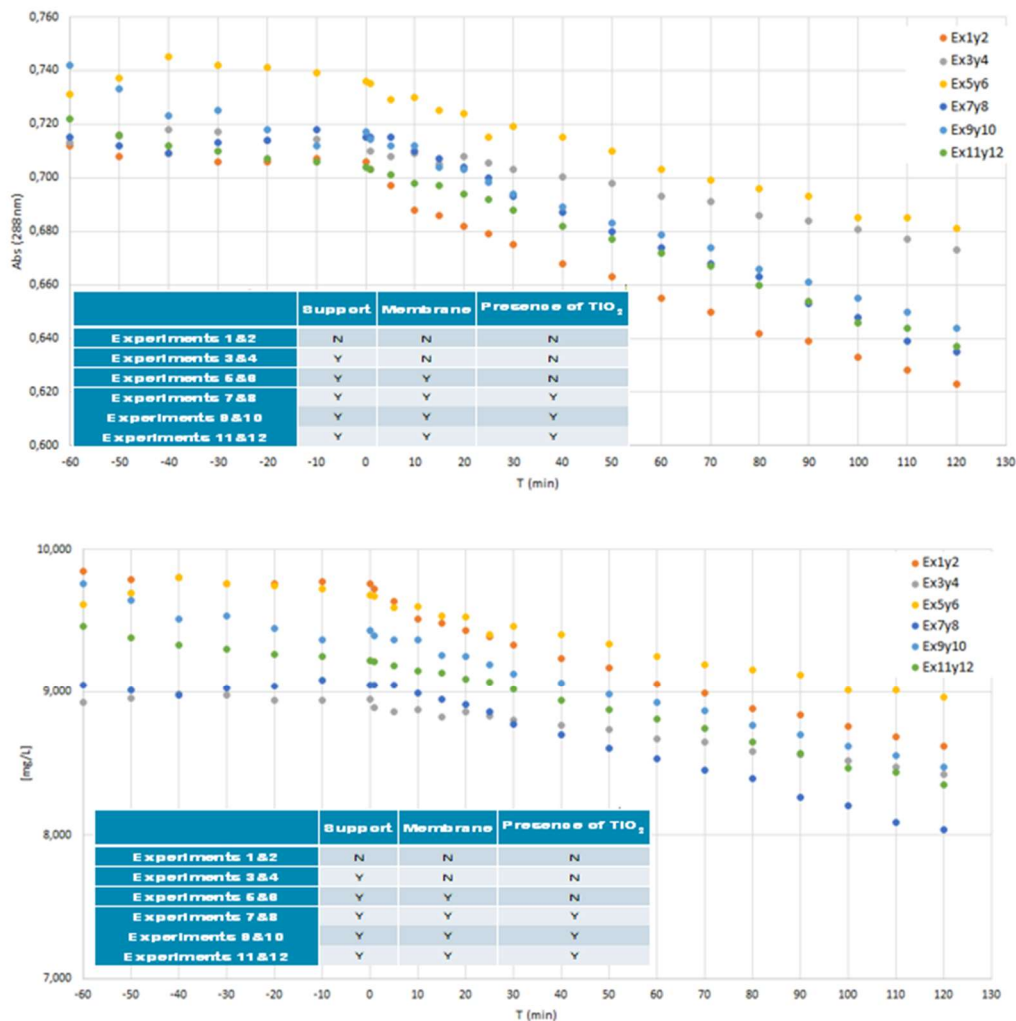

Figure 79. Time evolution of absorbance of the water at 288nm (top) and diclofenac concentration (bottom) in different tests in AOP+UV batch tests. The batch tests start at $t=0$.

Once corrected the incidences with the resistance of the thermoplastic structures, some batch tests were conducted by Aqualia. Although after inserting the structures, no effect on the water temperature was observed, Diclofenac was discarded since the UVc activity repolymerizes the diclofenac molecule, interfering on the absorbance, avoiding a right correlation between absorbance at 288 nm and concentration. The degradation rate improves when including TiO₂ vs. No-TiO₂ scenario, but not vs. the non-technology scenario. This can be explained by the interaction of the structure with UV. Thus, further steps are focused on improve the design of the membranes in order not to interfere on absorbance. New membranes with new geometry (2nd version) and new material composition will be tested.

2.5.4.2. Energy recovery pilot plant results

EL SAR[®]

After experiences in the lab- and pilot-scale level (see for example LIFE ANSWER), CS5 would represent the first known pre-commercial-scale experience. The upscaling of bioelectrochemical solutions in the wastewater sector have been considered by the



academic sector as a challenge itself from a techno-economical point of view (Park et al. 2020). Therefore, Aqualia considers that the design of this solution represents already a technical result, at least the issues related with process and bioelectrochemistry (understanding that the design of peripheral equipment is based on conventional industrial engineering). In this sense the size considered by Aqualia in the ELSAR® of CS5 would represent a real milestone to the sector and a significative step for the development of this cutting-edge solution.

To integrate a comprehensive industrial design a multi-sectorial expertise team has been built and coordinated by Aqualia (described as follows). The three areas interact since a change in one of the areas can affect to the other two.

- ELECTROCHEMISTRY PROCESS:

This activity is based on a scientist-technical assessment in bioelectrostimulated systems and processes. Some tests on the were done to assess the chosen materials.

- DESIGN, PRODUCTION AND QUALITY CONTROL OF ANODIC AND CATHODIC COLLECTORS.

The objective of this activity is to validate the process of manufacture, production and installation of the collectors. Up to now this process was done in the ELSAR® prototype, i.e., in a smaller scale.

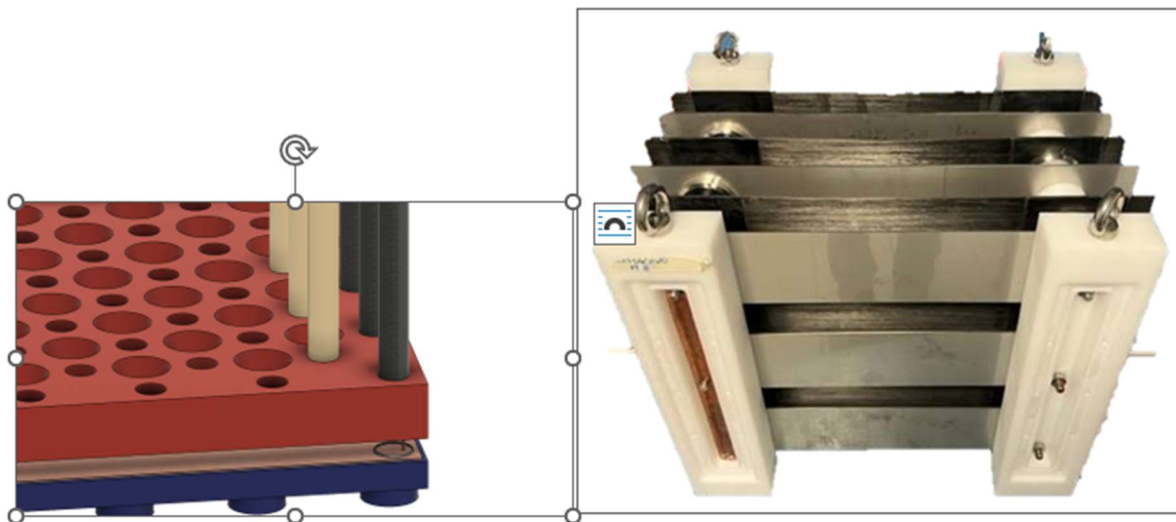

Figure 80. Left: Detail of a draft “tube-based” configuration of anodic and cathodic collectors, rejected because of its complexity, its low electrode surface and its high fabrication cost. Right: real picture of the prototype of the collectors (anodic and cathodic) to be tested in the ELSAR® prototype in January 2023. Electrode plates are less than 2mm thick, minimizing weight and material cost, and maximizing electrode surface.

The vertical-plates configuration allows the water and sludge circulation, with minimum interruption of upcoming streams. For the supporting and accessing of the collectors a platform is necessary; this platform must be also designed for not suppose an interference for the water circulation. The real modules will be stackable and will cover as much section of the reactor as possible, to maximize the contact with sludge.

The prototype has served also to define the needed quality control tests, not only in the assembling step (workshop) but also in the installation step (WWTP), which were:

- Certificate of conformity according to order and project drawings
- Certificate of materials.
- Pictures of assembly and of tests
- Dielectric and physical integrity tests.
- Sealing certificate.
- DESIGN OF HYDRAULICS: assessed by a Computational Fluid Dynamics (CFD).

The objectives are to understand the fluid-dynamic behaviour in the reactor, as well as to assess that the proposed design prevents from preferential ways or dead zones, and that the water distribution curve meets the mixing / expansion needs in the bottom of the reactor. Other questions to be researched are the role of upflow velocity, importance of granular size, biogas contribution to mixing and bed expansion and temperature influence on expansion, particularly on activated carbon.

To achieve results, several configurations were considered for the simulations. The study has been carried out using modelling and simulation tools using Computational Fluid Dynamics (CFD). A numerical model of the reactor has been developed, which solves the mass and momentum balances of each of the four phases, considering the interaction between them and the effect of turbulence. As a result, the simulation provides the fields of pressure, velocity, volumetric fraction and turbulence of the different phases. Based on these results, the flow pattern of each of the phases is analysed, allowing the evaluation of the fluid dynamic aspects of interest: water advance, bed expansion, etc.

It can be concluded that, generally, the design meets the needs, and that an upflow velocity of 6 m/h is enough to expand high concentration of biomass. Temperature has no significant influence, whereas biogas contributes significantly to the movement to the biomass.

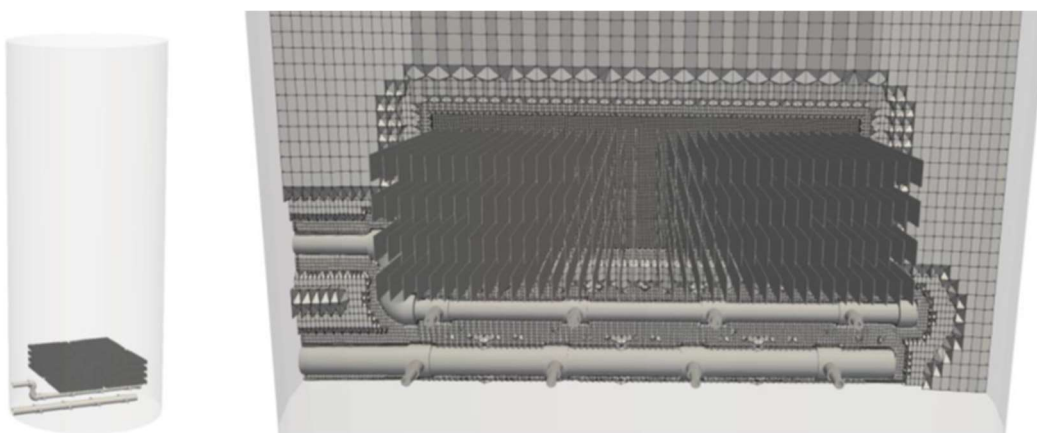

Figure 81. General geometry overview (left) and subunit modelling (right) of the model CFD of the bottom of the ELSAR reactor.

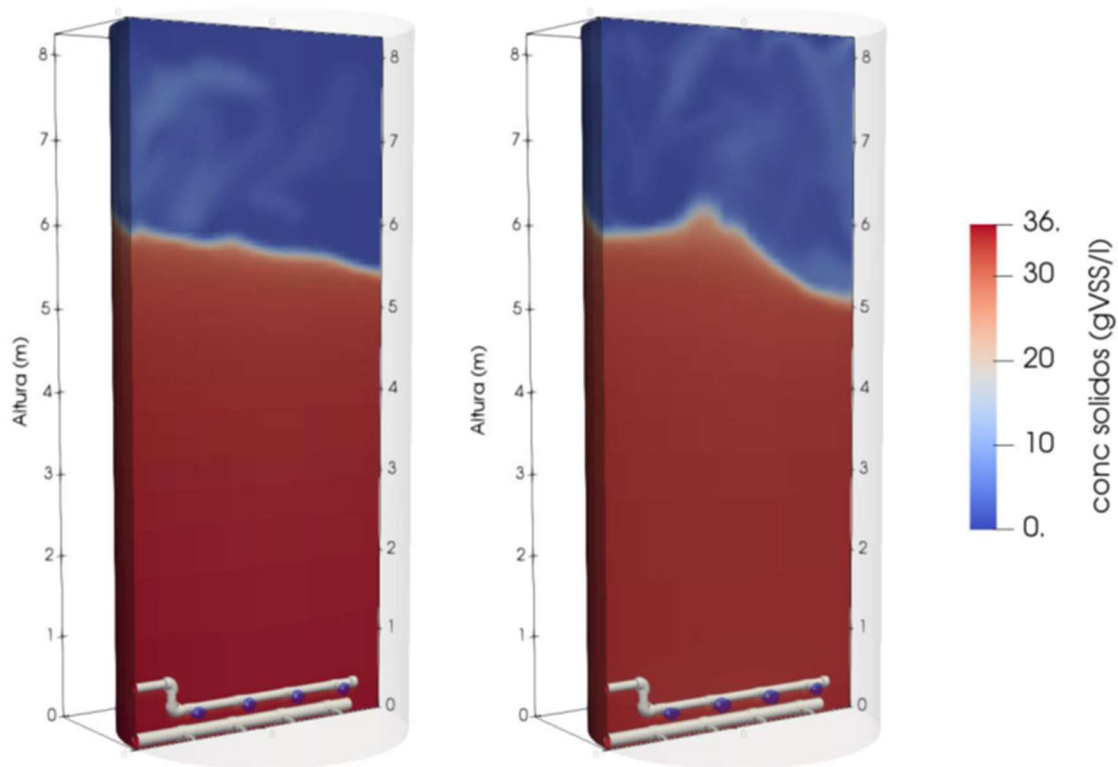

Figure 82. Influence of the size & density in the bed expansion, according to the CFD model. Both consider the biogas production. Left: big size diameter (1.3mm), right: low sludge density 1050 kg/m³.

Regarding the ELSAR® pilot plant, a new risk has arisen: the buffer tank of the existing WWTP contains a significant amount of suspended matter (TSS), contrasting with the one detected in the initial characterization (199 ± 99 mg/L, see previous table). High TSS in inlet wastewater can damage granular sludge of ELSAR®. The measures to be taken:

- Include a pre-treatment before the big pre-commercial scale ELSAR®, probably a lamella clarifier (to be defined, purchased and installed).

A small lamella clarifier (with capacity of ca. 2 m³/h) will be tested in order to confirm the suitability of this solution.

- Clean the bottom of the buffer tank (to be done in February 2023) in order to remove heavy and big particles (>2mm) that could have settled
- Locate the submersible feeding pumps in the right place.

This change of location has been done, and V30 results were reduced dramatically to normal levels (<50 mL/L). However, there are still episodes of very high content on solids in the inlet wastewater. Generated mainstream wastewater is screened and low in TSS, but some side-streams are not, and it is suspected that these side-streams, which are intermittent, may be the reason of sudden increases in TSS. Until the suspended solid content is uncontrolled and remains uncertain, it makes no sense to inoculate with granular sludge. Up to date, the reactor has worked without anaerobic granular inoculum to observe the good performance of the variables, observing only

acidification, but not methanogenesis. It could also be stated that the effluent is free of suspended matter, indicating good settling properties of suspended matter.

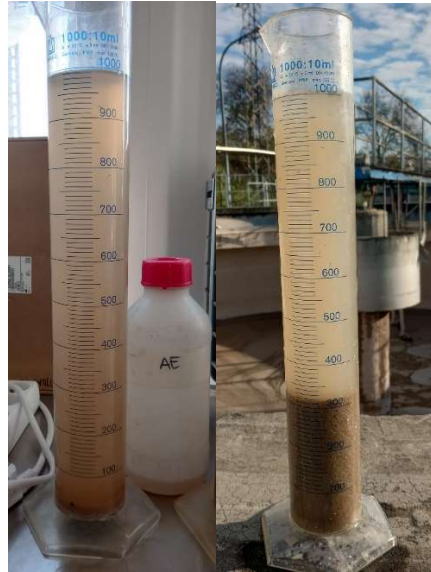

Figure 83. Example of V30 (settling of 1L sample after 30 minutes) in a normal wastewater sample (left) vs. a wastewater containing a very high amount of suspended matter (right).

2.5.4.3. Nutrient recovery pilot plant results

ThermoSolar-based device

In the batch tests, the technology increased dramatically the dry matter of the tested samples, after 7 hours at ca. 80°C:

- In wastewater dewatered sludge the dry matter increase was 2-fold
- In wastewater thickened sludge the dry matter increase was 10-fold
- In compost the dry matter increase was +50%, achieving in some cases almost the absolute removal of water.

Volatilization seems not to be significant, even after 7 hours at 80°C, although there seems to be some trend, particularly in compost samples (see next chart).

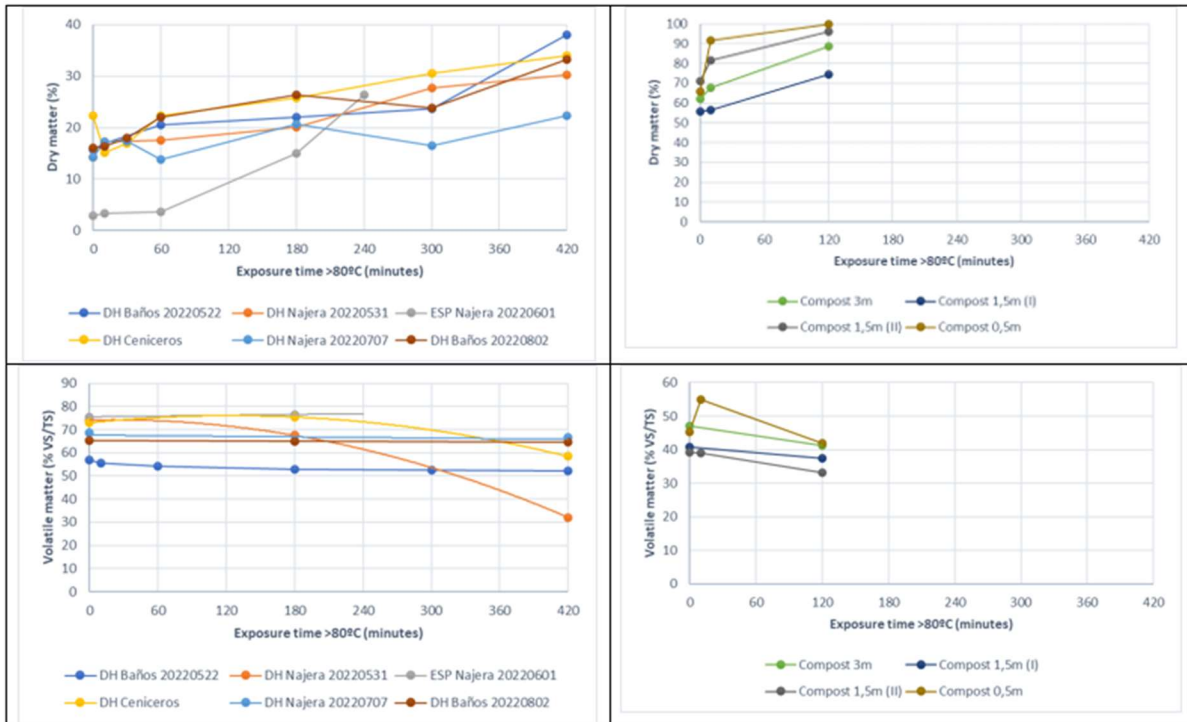

Figure 84. Top: Dry matter evolution in thermosolar batch tests with sludge (left) and compost (right). Bottom. Volatile matter evolution in thermosolar batch tests with sludge (left) and compost (right). DH = dewatered WWTP sludge; ESP = thickened sludge; Compost samples: “m” means month of composting age.

The explanation to the diversity of drying results between type of substrate (having obtained similar solar energy inputs) is to be found in the importance of the binding water of the solid substrate. The higher the dry matter in the substrate to be treated, the more bounded is the water in the substrate, i.e., the more difficult is to evaporate the remaining water:

- In thickened sludge, where dry matter usually represents less than 4% of total weight, there is a high amount of free water that easily achieves the evaporation state (see next chart). The drying rate has been 6-7 kg water / hour.
- In dewatered sludge, the drying rate has been only of 3-4 kg water / hour.
- In compost, the driest substrate among the tested, the increase is only of 50%, but, surprisingly, the drying rate was the highest (ca. 8 kg water/hour). This is probably because compost, a stable substrate, also contains high amounts of free water.



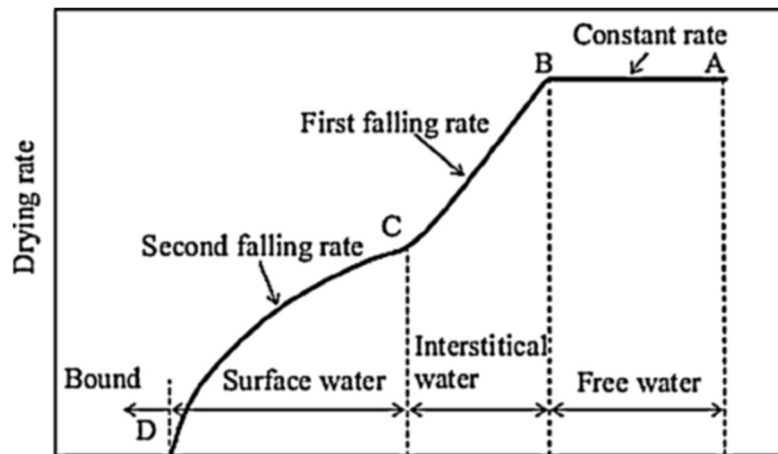

Figure 85. Correlation between drying rate and type of water bindings in biosolids [5].

The results prove that dry matter can be removed significantly in only one journey (7 hours) in a sunny day with normal sunlight irradiation ($700\text{-}900\text{ W/m}^2$), meaning there is a potential improvement vs. extensive conventional solar-based drying systems.

Some limitations have arisen during the batch tests:

- Temperature could not be increased in the HTC ranges ($>180^\circ\text{C}$). On the contrary, the temperature seems to achieve a stationary regime, being 100°C the maximum temperature achieved in the inside of the vessel.

A better heat distribution is to be expected by converting the batch / static configuration to a dynamic configuration. That would probably improve/shorten the exposure time of the system for any application (sanitation, drying or hydrolysing) and increase the temperature.

However, it is unlikely to increase so dramatically the temperatures (from 100 to at least 180°C), at least with the existing device. Furthermore, several ways of moving sludge have been considered, like pumps or screws. The former (pumps) have the following limitations: low tolerance to dry content ($<35\text{-}40\%$), high required pumping pressure (i.e. high energetic consumption), difficulties for steam evacuation and cost; the latter (screws) may tolerate better drier substrates and generated steam can easily exit the system, but are also costly and can require a complex engineering design.

The only way seems to provide more power to the system (i.e. more sun concentration or more mirror surface for the same amount of sludge) to get the needed temperatures. For instance, Ischia et al. 2019 [8] estimated in his basic process design for an industrial-size solar HTC installation that 1 m^2 of sunlight collector could arrive to treat 180 kg of dry matter. In the solar-based device of CS5, theoretically less optimized than an industrial-size, this ratio has been around 300 kg DM/ m^2 .

Additionally, isolation should be also considered in further designs for better heat accumulation.

In any case, HTC based on solar systems seems yet to be a low TRL technology, with still technical challenges, as is pointed out in references like in Ayala-Cortés et al. 2021 [3], therefore still far from the commercial level.



Finally, odour around the system were presents anytime during the batch tests. Since odours can't easily be captured in an open system, smelling nuisance can also represent a challenge to consider.

Regarding the sanitation of sludge (see next chart), batch tests provided different results in dewatered sludge:

- *E. coli* seem to be inactivated but the regulatory limits are only reached after 30 minutes, being 10 minutes usually not enough. Again, dynamic systems may improve this behaviour by better heat distribution among the sludge bed.
- Surprisingly, *C. perfringens* proliferation (up to +2 logarithmic units) has been observed after 10 minutes. After 30 minutes, the content was still high and far away from the regulatory limit. It is well known that “bacterial endospores present in sewage sludge (*Clostridium spp.*) are not destroyed using standard pasteurization procedures” and a two-step pasteurization is needed to inactivate endospores [1].
- *Salmonella sp.* was inactivated in all the sludge samples after only 10 minutes (data not shown).

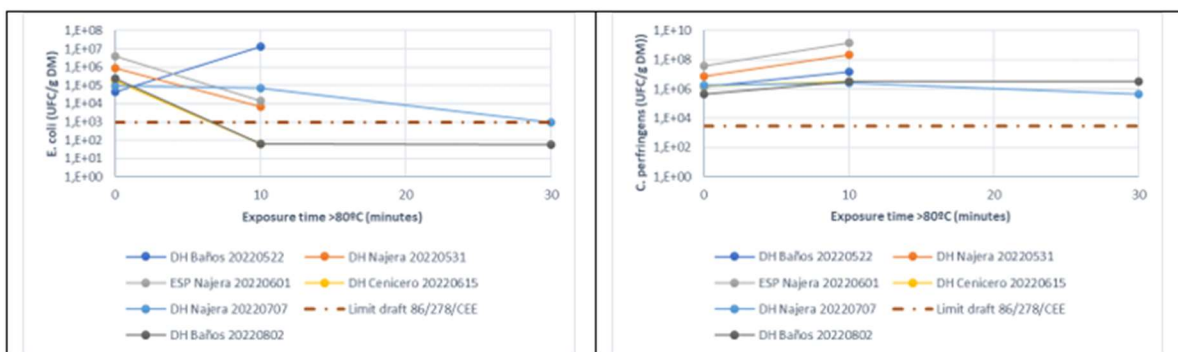

Figure 86. Evolution of *Escherichia coli* and *Clostridium perfringens* in sludge samples exposed to a thermosolar-based drying system at temperatures $>80^{\circ}\text{C}$.

Again, it can be concluded that, compared to extensive ambient-temperature solar-based systems high temperatures are achieved, and sanitation requirements can be met. However, (1) this conclusion is not valid for *C. perfringens* and (2) the system needs to be scaled-up, at least to a continuous configuration / productive approach. A better heat distribution system is essential to increase efficiency, and a second pasteurization (or higher exposure temperatures) is required. In this sense the remarks done previously for drying are also valid here.

Mature compost samples (> 1 month) already met sanitation requirements of the draft of regulation 86/278/CEE (see next table). Therefore, no thermic sanitation would be needed to this samples. However, in young compost samples, microbial content reduction is necessary for *E. Coli* and for *C. perfringens*. In this group, 10 minutes at 80°C were enough to meet the regulatory requirements. *Salmonella* was absent in all compost samples, independent of its maturity.



Table 33. Microbial inactivation performance in compost samples after 10 minutes at a temperature ca. 80°C.

Compost age (months)	Initial E. coli content (CFU/g DM)	Initial C. perfringens content (CFU/g DM)	Salmonella sp. (/25g)	E. Coli inhibition after 10 min	C. perfringens inhibition after 10 min
0,5	1153	3642	Not detected	>2	>1,8
1,5	772	772	Not detected	>1,6	>1,6
1,5	<14	253	Not detected	-	>1,3
3	<16	257	Not detected	-	>1,2

Meet draft 86/278/CEE requirements
 Does not meet draft 86/278/CEE requirements

Due to unavailability of the needed lab equipment, hydrolysis of thickened sludge could not be evaluated (in terms of increase in biogas productivity). Recent references, however, point out that exposure time of 4 hours (which is an achievable period of time in batch tests) at temperatures of 90°C can triplicate the soluble COD content (see next chart), which should increase significantly the biogas productivity (the correlation soluble COD – biogas productivity may not be linear). Low-temperature hydrolysis may not produce inhibitory compounds for methanogenic microorganisms, which provides an additional advantage vs. commercial intensive (high-temperature and pressurized) hydrolysis.

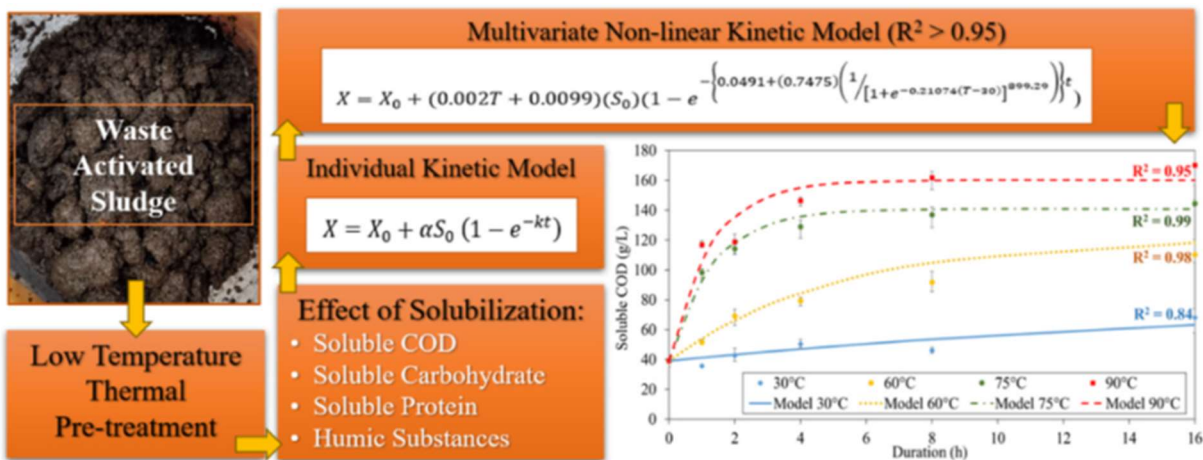

Figure 87. Summary of low-temperature hydrolysis of waste activated sludge [11].

2.5.5. Case study main conclusions

Nanofiltration and reverse osmosis pilot plant, with a treatment capacity of 2 m³/h, has been tested for 7 months (between January and September 2022). The obtained NF and RO treated wastewater met, without exception, all the legal requirements for water reuse. The tested technology showed to be robust, tolerating well the oscillations of the water and presenting a stable process in terms of membrane fouling. The pilot test allowed to define the optimal operation settings regarding the NF technology: flux 25 L/m²/h, crossflow velocity 0,2 m/s and recovery of 75%. Eventual accumulation of sludge at the suction point, biofouling growth in tanks with high retention times and low



velocities and microbial growth because of inadequate storage conditions are questions that should be considered in a further real design.

An advanced oxidation processes, combined with ultraviolet lab-scale plant with capacity of 18L/min was used (1) to evaluate the prototype in terms of geometry and materials of ceramic supported photocatalysts (CSP) and (2) to run batch tests to evaluate pollutant degradation rates. The first prototype allowed to improve the second one, by minimizing the shadow produced by the CSP, maximizing exposure of the photoactive phase embedded in the thermoplastic matrix, avoiding the re-precipitation of the tested emerging pollutants, and selecting structures that can resist the normal conditions of a disinfection treatment (vibration, friction, turbulent regimes, etc). Diclofenac has been found not to be an interesting indicator for micropollutant since the UVc activity repolymerizes the diclofenac molecule, interfering on the absorbance. The degradation rate improves when including TiO₂ vs. No-TiO₂ scenario, but not vs. the non-technology scenario. New membranes with new geometry (2nd version) and new material composition will be tested.

Regarding ELSAR®, a pre-commercial industrial-size plant with capacity of treating 20 m³/h of brewery wastewater or an equivalent of 2000 kg COD/day will be built in 2023. The expected biogas production will be 31 Nm³/h. To Aqualia's knowledge, would be the first big-size plant of his kind in the world. A multi-sectorial expertise team has been built in order to get a comprehensive industrial design, integrating (1) electrochemical process, (2) design, production and quality control of electrodic collectors and (3) design of hydraulics. Due to the delays in the pre-commercial ELSAR®, a pilot ELSAR® has been installed. It will treat real brewery wastewater, aiming the validation of processes and structures. The pilot plant contains all the needed elements for simulate in a pilot-scale the same process than in the big-scale, although some processes (like biogas treatment) are inexistent. It is expected to be run beginning 2023 and a capacity of ca. 5 m³/h.

After installation during all 2022, the AnMBR pilot plant will be commissioned (by means of using anaerobic inoculum) in December 2022, with a capacity of treating ca. 2 m³/h or around 50 m³/d, and a biogas production of ca. 3,5 m³/h.

After installation in spring 2022, the safety inspections in summer 2022, and the commissioning in autumn 2022, the solid oxide fuel cell pilot plant will be commissioned in December 2022, with a capacity of producing 1,3 kWelectric and a approx. consumption of 10 m³ of biogas/ day. It will be fed with pre-treated biogas.

Thermosolar-based device has been tested in the batch tests, after 7 hours in a sunny day with normal sunlight irradiation (700-900 W/m²), the tested technology increased between 0,5 and 10-fold the dry matter of the tested samples, depending of the type of sludge (dewatered, thickened or composted). Temperature could not be increased in the HydroThermal Carbonization ranges (>180°C), which forces further research for optimize solar heat profit. Through the tested thermal treatment, Salmonella sp. was easily inactivated, but *Escherichia Coli* and especially *Clostridium perfringens* were not always inactivated even after 30 minutes of treatment. Again, a better heat distribution may help to obtain better results.





2.6. CS6 Karmiel and Shafdan (Israel)

2.6.1. Brief description of the case study and objectives

The agro-industrial sector causes high organic load peaks at the wastewater treatment plants. Sources include agriculture, food industry, olive oil mills and water treatment. The partners involved in the project are AgRobics Ltd. (AGB), the Galilee Society – Institute of Applied Research (GSR), Mekorot company (MEK), all in Israel, and Greener than Green Technologies AE (GtG) in Greece. The symbiosis tries to enable the protection of the existing WWTPs in Karmiel and the Shafdan, as well as other similar plants and systems, from any sudden shocks of strong and problematic agro-industrial wastewater (i.e. olive mills, slaughterhouses, wineries, dairies etc). In addition, the produced biogas during the process will be used to generate power, as an added-value renewable energy source within the context of circular economy. As such, concepts such as water treatment (Karmiel WWTP), resource recovery (polyphenols), biogas production and water reuse, are key.

The Karmiel municipal WWTP in northern Israel includes pre-treatment, physical settling, biological treatment (activated sludge-based) and tertiary treatment (sand filtration). The plant faces problems due to shock loads from olive mill wastewater (OMW) during the harvest period and due to the illegal discharges from slaughterhouses in the area. There is an old pilot plant at the site, as well as an ongoing demonstration plant of the proposed technology to anaerobically treat the raw wastewater, prior to the aerobic biological process. So far, no solution has been implemented for the upstream and on-site wastewater pre-treatment, although it is technically feasible, economically viable and socially acceptable. Thus, part of this low-treated wastewater is discharged to the environment, without adequate treatment.

The Shafdan WWTP located south of Tel Aviv is Israel's largest WWTP (400,000 m³/d), and collects, treats, and reclaims municipal wastewater in this rapidly growing area. The system consists of conventional activated sludge, including thermophilic anaerobic digestion, followed by a separate facility that provides Soil Aquifer Treatment (SAT) to produce reclaimed water for reuse in agriculture.

Within the ULTIMATE project, CS6 aims to close the loops of water, material, and energy. Therefore, the specific objectives and the methodology for each category are:

1. Increasing the production of biogas through the application of advanced anaerobic technology (AAT) in Karmiel system, and a combined AAT and AnMBR system in the Shafdan system, as pretreatment of the domestic wastewater mixed with agro-industrial effluent (i.e. wastewater from olive mills, dairies, wineries and slaughterhouses).
2. Extraction of valuable materials (polyphenols) from OMW before mixing with domestic wastewater.

2.6.2. Technological solution in ULTIMATE project: pilot plant description

Technological solution for both CS6 sites are explained in further detail.





2.6.2.1. Biogas production from anaerobic pre-treatment of municipal and/or industrial wastewater in Karmiel

An immobilized high-rate anaerobic system (AAT) from a previous H2020 project (SMARTPlant), as an anaerobic pre-treatment, was modified as a retrofit of the existing WWTP in Karmiel. The system serves as a barrier for mixed agro-industrial wastewater in the municipal plant, thus protecting the aerobic system against shock loads. This includes:

- Direct pre-treatment of pure OMW wastewater.
- An existing demo plant was upgraded, optimized, and has been operated under different scenarios of discharge of OMW wastewater.

Currently, the AAT pilot receives 120 m³/d of wastewater with a COD, TS and TVS loads of 238 kg/d, 97 kg/d and 88 kg/d, respectively. The biogas production rate is 0.3 Nm³/h with a methane content of 70% on average.

Currently, 98.4–99.6% of the municipal wastewater (WW) is mixed with 0.4 – 1.6% olive mill wastewater and treated anaerobically by the AAT to produce biogas.

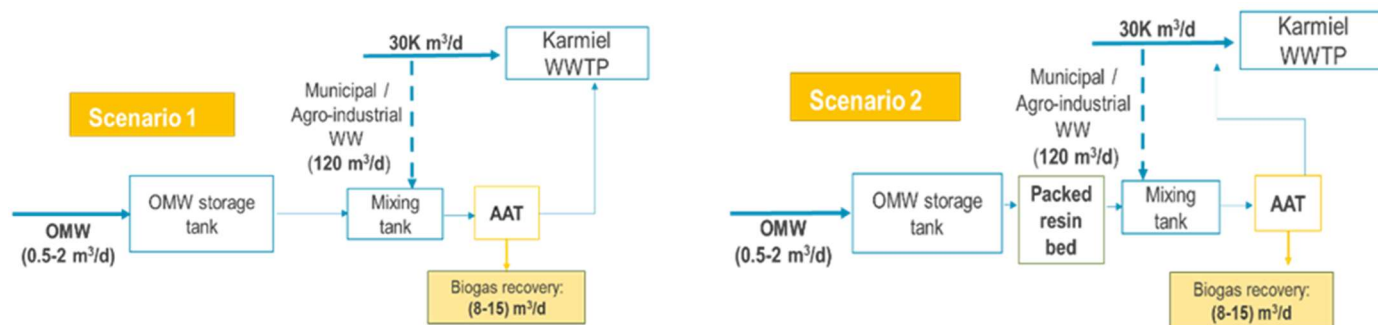

Figure 88. Schematic description of biogas production (Scenario 1) and polyphenols recovery (Scenario 2).

2.6.2.2. Recovery of high-value products from olive mill wastewater in Karmiel

A pilot plant system with an adsorption column has already been delivered by Greener than Greener (CS4). It will be operational by the end of December 2022, to test the removal and recovery of polyphenols from olive mill wastewater (OMW). Its implementation can be seen in Figure 88.

The polyphenols to be extracted from OMW are considered a high-value product, as olives are rich in polyphenols (range from anywhere between 50 – 5000 mg/kg). The polyphenols will be captured by passing the OMW through an adsorbing resin, then they will be extracted, using pressurized hot water, in a concentrated form as a crude extract. The system, serving as a pre-treatment of OMW, will be designed for 60% reduction in the total phenolic content, measured by a suitable analytical technique (e.g. HPLC or spectrophotometry) before AAT. This will enable resource recovery and improve the performance of downstream systems by removing inhibitory compounds, such as polyphenols upstream to the treatment.





2.6.2.3. Combining anaerobic biofilm treatment with membrane filtration and activated carbon in Shafdan

To improve the biogas production and the effluent water quality, an immobilized biofilm AAT is combined with membrane filtration and activated carbon at the pilot-scale. The pilot at the Shafdan has been installed, and its operation was started in August 2022. This demonstration system represents a very large WWTP, in order to provide insight into the capability of large WWTPs to combine agro-industrial wastewater. The AAT-AnMBR combination will make the treatment system more flexible, allowing it to better handle drastic changes in wastewater composition, i.e. OMW, winery and dairy effluents, plus domestic wastewater during periods with low industrial wastewater discharge. The addition of activate carbon will decrease the inhibitory effects of high concentrations of polyphenols and tannins from olive oil mills, thus increase biogas production.

The demonstration plant at the Shafdan receives 12-24 m³/d of municipal wastewater with a COD load of 0.5 m³/d. That volume (12-24 m³/d) will be mixed with 0.2-2 m³/d of OMW wastewater and will be further treated by AAT and AnMBR systems to produce biogas, as shown in Figure 89.

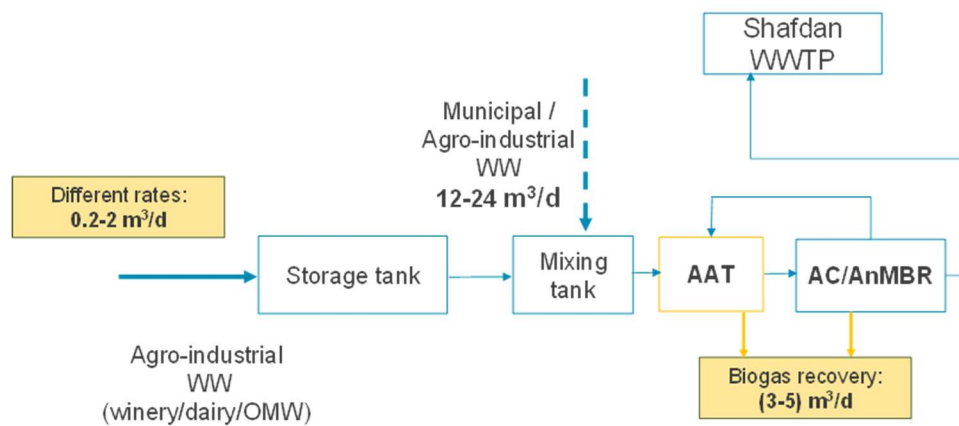

Figure 89. Schematic description of Shafdan system).



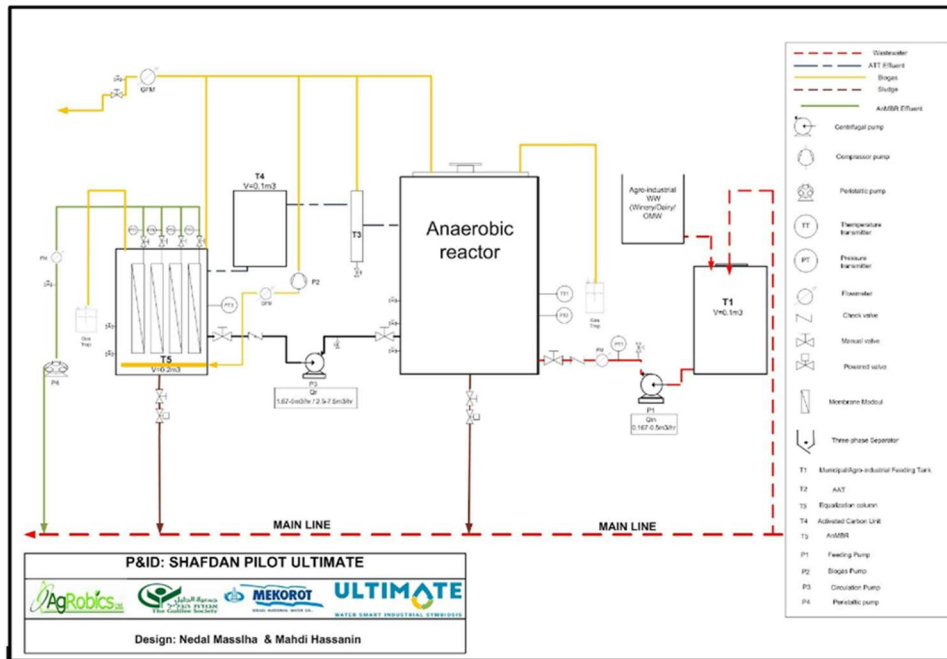

Figure 90. PID of the Shafdan system.

2.6.3. Start-up operation

The Karmiel system (for tasks 1.3.3 and 1.4.5) had a smooth start-up, as this system has already been constructed on the site for another Horizon2020 project (SMARTPlant). The system as proposed was modified and upgraded for the treatment of combined agro-industrial wastewater (i.e. olive mill wastewater) with domestic wastewater. The start-up was conducted last year (months 12-18), when the system was operated for part of the first scenario (testing the maximal ration of OMW/domestic wastewater); see the preliminary results in Section 2.6.4 below.

The second use of this system will be conducted after integrating the polyphenol extraction unit from GtG, which has just arrived (end of November 2022). We anticipate completing its installation and start-up in the coming two months. For this, representatives from GtG will visit the site during December 2022 to train the technical team of GSR and AgRobics to properly operate this unit.

Shafdan system (task 1.3.4): The goal of this system, as described, is to increase the production of biogas while providing a high-quality effluent. A combination AAT (same technology as Karmiel's) and a membrane unit will be used (Figure 89 and Figure 90).

1. After connecting the system with the inlet of wastewater (after filtration), the AAT system was started in August 2022, to reach a steady state of the anaerobic unit (fixed foam-based AAT system), before connecting it to the filtration (membrane) unit, between August and October 2022.
2. The filtration system (membrane) was mechanically and electrically commissioned, and a thorough check of the sensors and valves was done. Many issues related to the sensors, electrical panel and control system took about a month to be resolved with the support of SFCU staff, the unit manufacturers (until end of September 2022).



3. The membrane units, including connections, were tested with tap water, again with the support of SFCU engineers.
4. The membrane system was next connected to the outlet of the AAT system (on November 7, 2022), and the first complete run was started with 0.5 m³/hr. From that time until November 16, intensive training on the automatic operation/monitoring was given by SFCU staff to the technical team of GSR/Agrobics/Mekorot.
5. This week (starting on November 27), the sampling campaign was started according to the sampling plan. However, the technical staff observed a hydraulic problem, which solution was identified, and will most likely be fixed soon to complete the start-up process of the entire system before the end of 2022.

2.6.4. Results from pilot plant operation and discussion

The results from the Karmiel system are presented in Figures 4-6 below.

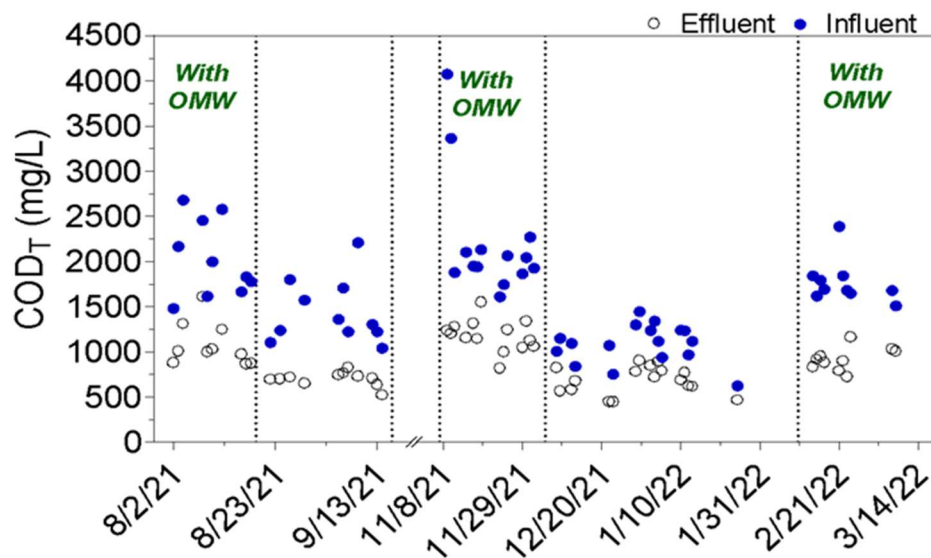

Figure 91. Total COD as a function of time after the AAT at the Karmiel system.



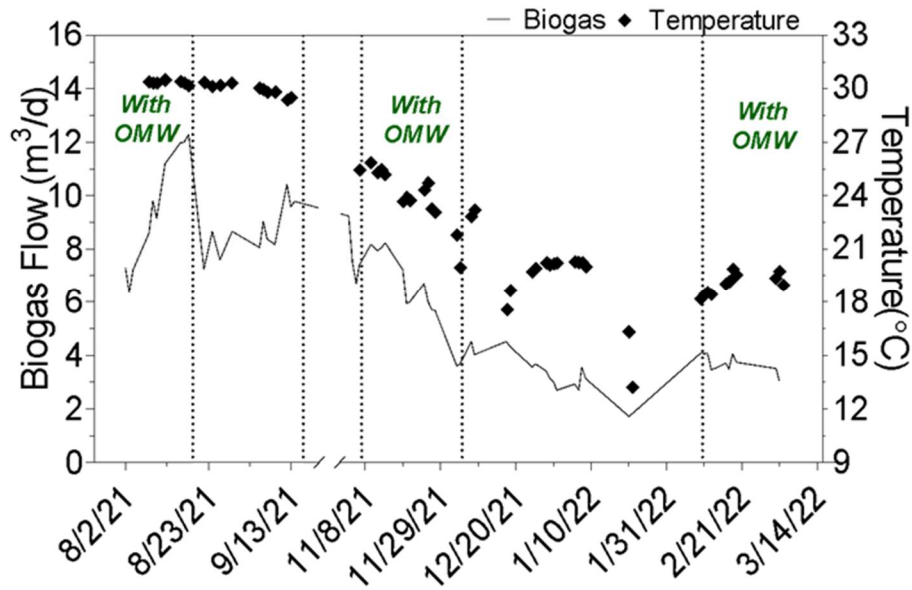

Figure 92. Biogas flow and temperature as a function of time from the AAT at the Karmiel system.

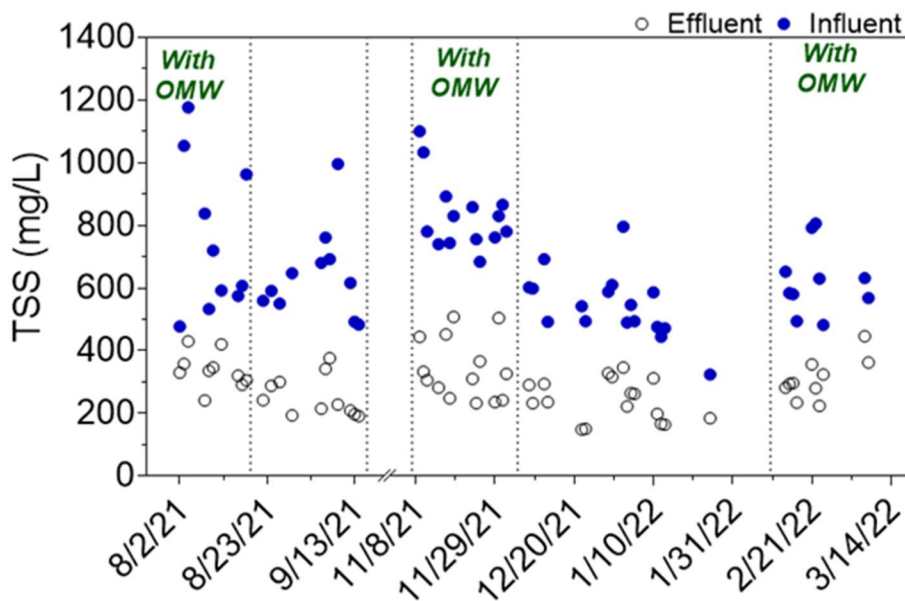

Figure 93. Total suspended solids (TSS) as a function of time after the AAT in the Karmiel system.

2. Summer period: COD removal of 46% was obtained for a COD_{in} of 2,280 mg/l (WW+OMW), while the removal was 49% of 1,430 mg/l (without OMW).
3. Winter period: COD removal of 47% was obtained for a COD_{in} of 1,770 mg/l (WW+OMW), while the removal was 36% of 1,088 mg/l (without OMW).
4. The addition of OMW showed an increase of the biogas production while the process was highly dependent on temperature. However, it is clear from the above figures that the system tolerates the applied ratio of 0.5 m³/d of OMW per 120 m³/d of domestic wastewater.





For the next step, we will test the system under two different scenarios: (1) increase the ratio until we reach the maximal possible OMW ratio that can be applied without any negative effect on the anaerobic process; (2) integrate the polyphenol extraction unit of Greener than Greener (CS4) that has just arrived. This system will have two purposes, to extract the valuable polyphenols, and also, possibly, to allow a higher ration of OMW after polyphenol extraction (assuming that inhibition is caused mainly by the polyphenols). These two scenarios will be tested in the coming year.

2.6.5. Case study main conclusions

Within this case study we have two different units (pilot) in two sites. The first, at Karmiel (north of Israel) was commissioned on time according to the original plan, where the report summarizes the main outcomes of the operation of this unit during the last year. A sub-unit that is related to the application of the Greener than Greener (CS4) technology and focuses on the material recovery (polyphenol extraction). This was also commissioned two months ago, where the operation of this one is in progress.

The unit in Shafdan (biggest WWTP in Israel). also was commissioned (delay of three months). This unit started last fall. The late start up time (low temperature for anaerobic activity) led to a slow rate to reach the steady state. Also, we had some problems with one of the membrane units (of 8) that was omitted a few weeks ago. Meanwhile we have restarted the operation with a boost of external sludge inoculum to speed up the process.

2.7. CS7 Tain (United Kingdom)

2.7.1. Brief description of the case study and objectives

Case Study 7 is the Glenmorangie whisky distillery located in Tain, in the north-east of Scotland. The current effluent treatment plant, at the start of the symbiosis between the distillery and the water sector, was designed and installed by Aquabio, partner in the project, and consists of screens followed by an anaerobic membrane bioreactor (AnMBR) to treat the wastewater generated during the whisky making processes and allows to discharge the treated effluent in the local estuary, the Dornoch Firth (Figure 94).



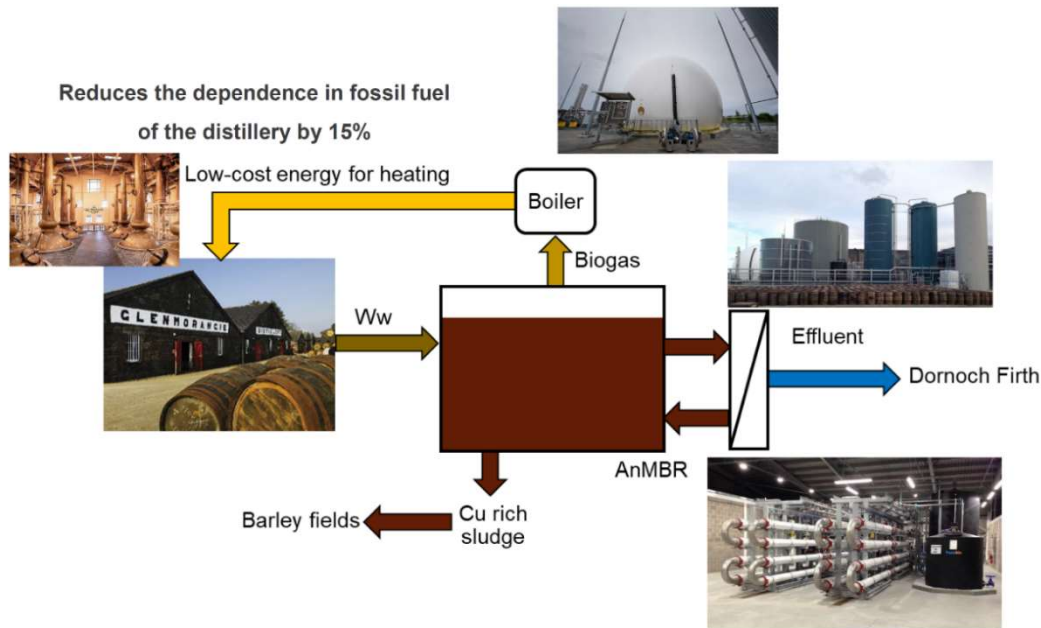

Figure 94. Pre-existing system at the distillery before the start of ULTIMATE.

On average, the distillery produces daily 322 m³ of wastewater with a COD load of 10.7 t/d corresponding to an organic loading rate of 4.9 kg COD/(m³*d) for the AnMBR. In the AnMBR, the COD is biodegraded to biogas with a methane yield of 0.27±0.05 Nm³ CH₄/(kg COD*m³). The biogas is converted to heat in a boiler and then reused to heat the stills. Based on the methane content of the raw biogas, the potential for onsite energy production is on average 28.8 MWh/d, however a fraction of the treated biogas can be flared (5% on average daily), depending on the demand on site. Overall, this reduces the dependence in fossil fuels of the distillery by 15%. In addition, the excess sludge produced in the AnMBR is provided to the local farmers for application to the fields as soil enhancer. Finally, the Glenmorangie distillery is part of the Dornoch Environmental Enhancement Project which aims to restore Native European oysters and enhance biodiversity in the Dornoch Firth for the benefit of the local environment and community.

It should however be noted that the effluent for discharge still contains concentrations of ammonium and phosphorus of about 800 mg/L and 250 mg/L, respectively, offering potential for recovery as fertiliser for example. Also, the AnMBR is operated in the mesophilic range; thus, its effluent has a temperature between 35 °C and 40 °C which provides an opportunity for residual heat utilisation within the facilities. Finally, if the effluent was to be further treated, the water can be reused at the distillery for cleaning purposes for example. As part of ULTIMATE, Aquabio and Cranfield University (partners in the project) are then collaborating with the Glenmorangie distillery and Alpheus, the current operator of the treatment site, (both stakeholders but not beneficiaries) to evaluate options to expand the circular economy approach at the site with residual heat utilisation, nutrients recovery and water recycling.

As the wastewater contains high levels of both nitrogen and phosphorus, it was decided to apply a two-step approach for the recovery of the nutrients. The effluent will be first processed through a precipitation system for the formation of struvite ((NH₄)MgPO₄·6(H₂O)). As the ammonia is in excess, this step will be focused on



maximising the removal of the phosphorus with a target of 80%. The effluent will be further treated in a stripping unit for the removal and recovery of the remaining ammonia present with an overall ammonia recovery target of 90%. In this case, the ammonia will be recovered in the form of an ammonium sulphate solution. Both products recovered can be used as fertilisers by the local farmers.

The effluent will then be treated by reverse osmosis (RO) membranes to generate high quality water that can be reused within the distillery and partially close the water loop. This will in particular allow to reduce the distillery's freshwater consumption. It is important to note that the recycled water will not be used for the whisky making process where natural water is used but can be reused for other applications such cleaning processes. Finally, the residual heat available in the effluent after the AnMBR will be used to reduce the energy demands of the subsequent stages. Indeed, the stripping process can be controlled through a balance between temperature and chemical use (pH adjustment). Similarly, an effluent at higher temperature has the potential to reduce the energy demand during the filtration through the RO membranes due to the reduction in the viscosity of the water.

Overall, the case study aims to deliver technological solutions which will help strengthening the existing symbiosis between the distillery, the water sector with technology providers and operators and the local farmers.

2.7.2. Technological solution in ULTIMATE project: pilot plant description

For the nutrients recovery, as stated above, the approach applied here comprises two stages which are being investigated at demonstration scale. The first step, the precipitation process consists of a 5 m tall reactor followed by a clarifier (Figure 95). The aim of this process is to achieve controlled formation of struvite ($(\text{NH}_4)\text{MgPO}_4 \cdot 6(\text{H}_2\text{O})$). As the magnesium is the limiting compound in this water, magnesium chloride is being dosed in the effluent before it enters the reactor. Also, as it is established from the literature that struvite crystallisation is optimum at pHs between 8 and 8.5, the pH of the water is adjusted through the addition of sodium hydroxide (NaOH).

The reactor itself is made of four cylindrical sections with increasing diameter from bottom to top (labelled as zone A, B, C and D). As the conditions are adjusted through the dosing of the chemicals and the effluent is fed at the bottom to the reactor, struvite crystals will form and due to the mixing within the reactor, the small crystals will agglomerate and form pellets. As the water flows up in the larger sections of the reactor, the velocity gradually decreases which allows for the precipitates formed to stratify with the finer particles present at the top of the reactor and the larger particles settling towards the bottom sections. To ensure good mixing and controlled velocities in the reactor, a recirculation loop is fitted to take the water from the top section of the reactor and mix it with the incoming water at the bottom of the reactor. The treated effluent then overflows at the top of the reactor and reaches the clarifier by gravity. The clarifier provides additional safety to remove any remaining particles from the effluent to avoid clogging issues in the subsequent stages of the process. As the larger pellets of struvite formed will accumulate in the bottom section of the reactor (zone A) over time, they will then be harvested. The harvest process can be triggered either manually or through a change in differential pressure in the reactor or time. During the harvesting



process, the section A is isolated, but operation is allowed to continue as the effluent is fed directly to the section B above through a by-pass. The content of section A is then flushed into a holding tank.

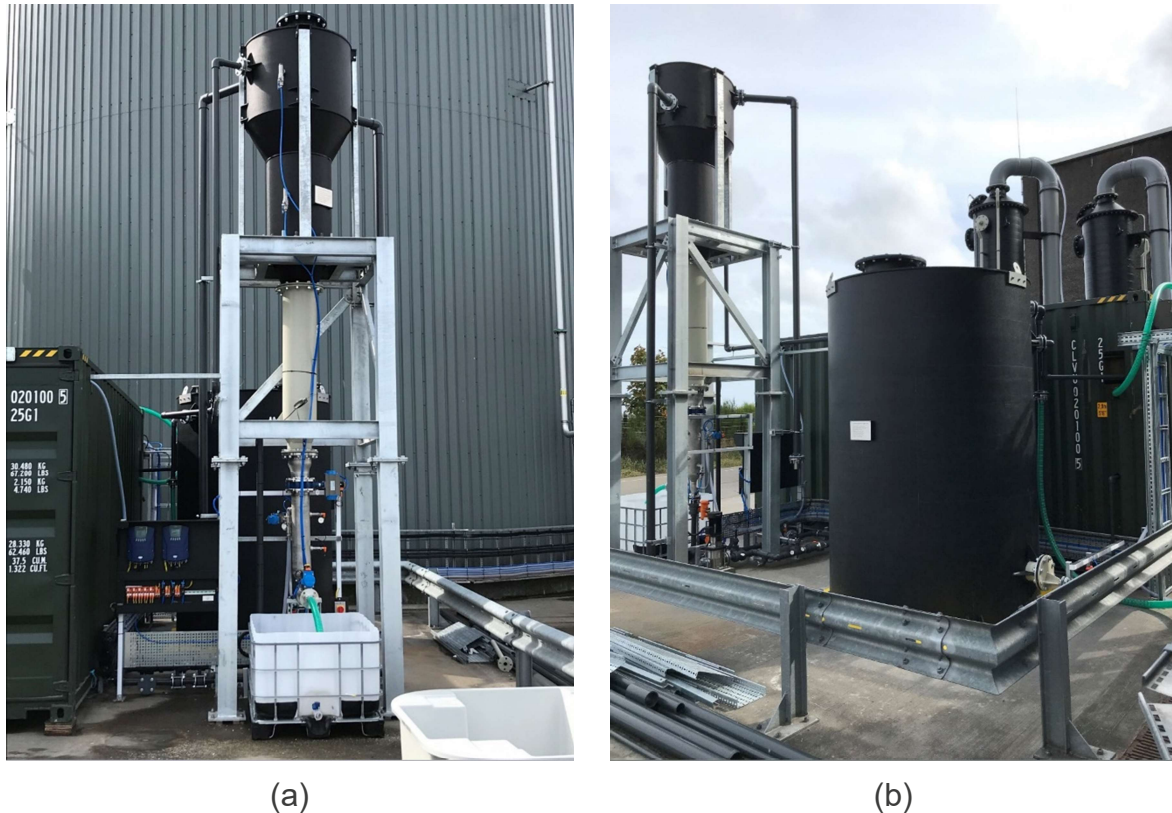

Figure 95. Struvite precipitation unit ((a) precipitation reactor and (b) clarifier).

The second stage for the nutrients recovery is an ammonia stripping unit, a commercial product supplied by Forbes (Figure 96). This process relies on the fact that free ammonia (NH_3) is volatile so it can be easily transferred from a liquid to a gas phase. For this, to ensure all the ammonium (NH_4^+) present in the water is converted to ammonia, the pH has to be increased to 10.5-11 through the addition of NaOH. The pH adjusted effluent is then pumped at the top of the packed stripping column (5 m tall). As the water trickles down on the media in the column, which provides an increased surface area for a better transfer, air is pumped at the bottom of the column. When the water and air come in contact, the ammonia is transferred into the air.

The treated effluent flows out at bottom of the column for further processing or discharge. The ammonia rich air is then transferred into a second column to recover the ammonia by scrubbing. In the scrubber, the air is again fed at the bottom of the column but in this case, a concentrated acid solution (sulfuric acid) is recirculated in the column. As the ammonia rich air comes in contact with the acid, a reaction occurs to form an ammonium sulphate ($(\text{NH}_4)_2\text{SO}_4$) solution. The used solution is taken out of the system when its pH increases above a set level (to be determined as part of the operation), indicating high levels of ammonia have been recovered. The system is then topped up with fresh acid solution for the process to continue.

Both units are designed to treat a flow of 1 m³/h. The systems are fully automated and are fitted with sensors including flow meters, pressure gauges and pH and conductivity probes for operation and monitoring.



Figure 96. Ammonia stripping/scrubbing unit.

For water reuse, a reverse osmosis pilot unit is used (Figure 97). The system is designed to treat flows of up to 1 m³/d and is semi-automated. The reverse osmosis technology relies on the rejection of dissolved compounds (organics and salts) as the water permeates through a dense membrane. The unit comprises a feed tank fitted with a heating system to control the temperature of the feed water. This will be of particular interest for the evaluation of residual heat utilisation, to understand the impact of temperature on the treatment and operational performance of the RO membranes. The water is then pumped with a high-pressure pump into three pressure vessels which can be operated either in series or in parallel to investigate increased throughputs or recoveries. The pressure vessels are fitted with TriSep 1812 X20 membrane elements. As part of the trials, it is possible to vary the feed flow rate and pressure applied and monitor the pressure and permeate flow rate to determine optimum operational and treatment conditions.

Finally, for the investigation of the residual heat utilisation, the heating system fitted in the RO membrane unit as well as another heater fitted in the feed tank of the precipitation and stripping units allow to vary the temperature in the different streams and to investigate the impact of temperature on the different processes. It should be noted that the effluent from the AnMBR already contains residual heat at temperature between 30 to 35°C and the heaters will be used to simulate further changes at the different stages. The aim of this part of the work is to identify optimum operational conditions for the different treatment systems in order to minimise energy demand by

the new systems. The learnings will then be transferred to future designs for optimum utilisation of the residual heat combined to use of the heat produced from the biogas.

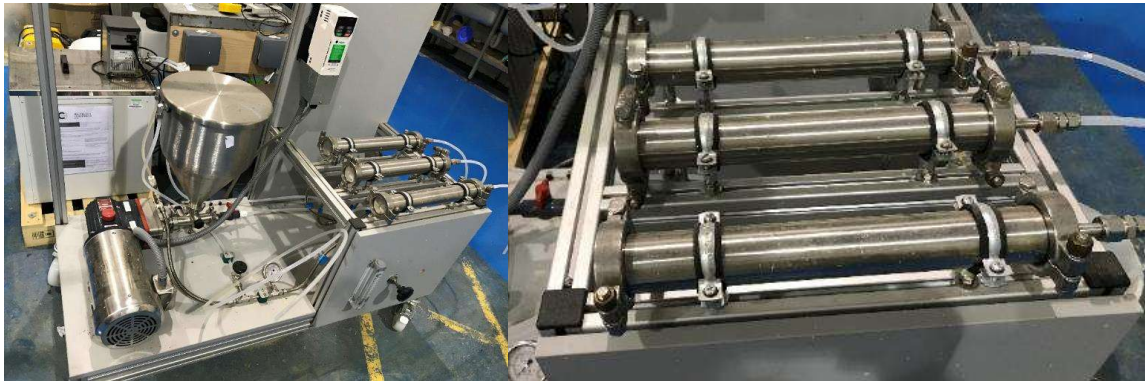

Figure 97. Reverse osmosis unit.

2.7.3. Start-up operation

The RO membrane unit was operational from August 2022 and the nutrients recovery units were commissioned in early September 2022. Due to the nature and size of the nutrients recovery systems, over the past few months activities have focused mostly on these units and limited trials were conducted at pilot scale towards the other tasks. For this reason, the following sections will mainly report on the precipitation and stripping systems.

After commissioning of the demonstration plants, operation was started for the precipitation stage alone. The initial conditions applied were based on the optimum conditions reported in the literature for struvite crystallisation with a pH of 8.3 and a Mg:P molar ratio of 1.3:1. The system was operated at 1 m³/h. Although the system delivered good performance (details below), significant scaling of the pumps, pipes and dosing points was experienced rapidly, after only a few days of operation. This led to a review of the design and operation of the system and it was restarted after a number of modifications were made (details below). In an attempt to avoid some of these issues, the system was restarted with more conservative conditions which were then modified over time. First, the feed flow rate was reduced to 0.5 m³/h. Also, pHs of 6.5 (acid dosed) to 8, recirculation rates of 7 and 14 times and Mg:P molar ratio of 1:1 were tested in the following months.

The stripping unit was then operated when stale conditions were obtained from the precipitation step. The stripping was started at a feed flow rate of 0.5 m³/h and the pH was adjusted to 10. The acid solution was prepared for sulphuric acid solution of 5% (V:V) corresponding to a pH just below 2.

2.7.4. Results from pilot plant operation and discussion

Before the commissioning of the pilot plants, regular samples were collected from the AnMBR effluent to monitor the levels of the different compounds to be fed to the nutrients recovery and water reuse units (Table 34). The results confirmed the high levels ammonium and phosphate expected with average concentration of 804 mg N/L and 209 mg P/L, respectively. Also, it is important to note the concentration of magnesium at 41 mg/L. As stated above, this confirms that magnesium is the limiting



compound for the formation of struvite so to ensure maximum removal of the phosphorus, additional Mg will have to be dosed in the system.

It should be noted that the pH reported here is after acidification. Indeed, the full scale site has faced issues of precipitation in the AnMBR permeate which has impacted the discharge pump and pipes so to limit precipitates formation the pH is decreased after the UF membranes. For the purpose of the trial and to save on chemicals, because the pH of the water has to be increased to about 8 for the formation of struvite, it was initially decided to feed the demonstration units with the AnMBR permeate without acidification. As it will be shown later, this created problems and the feed was then changed to the acid dosed permeate. The solids levels are thought to be very high considering that the effluent went through ultrafiltration (UF) membranes but this can also be explained by the formation of precipitates after the membrane which would contribute to the total suspended solids (TSS) measurement. It is important to note that other compounds such as calcium (371 mg/L) and potassium (692 mg/L) are present at significant levels in the water as may contribute to the formation of other precipitates. Finally, some metals such as iron, zinc, nickel and copper are also present which could lead to some contamination of the product formed. The copper levels were however lower than expected as the wastewater from the distillery is known to have high levels of copper leaching out from the copper stills used in the whisky making process. However, a significant fraction of the metals including copper is likely to have partitioned onto the solid sin the AnMBR and will be present in the sludge rather than the water.

Table 34. Characteristics of the AnMBR effluent.

Parameter	Unit	Average	Standard deviation	Number of samples
pH	-	7.2	0.3	34
EC	mS	5.9	0.6	34
TSS	g/L	0.08	0.13	34
CODt	mg/L	559	194	34
TN	mg/L	824	76	32
TAN	mg/L	804	97	34
PO ₄ -P	mg/L	209	23	34
Alkalinity	mg/L as CaCO ₃	3265	791	33
Cl	mg/L	255	45	34
NO ₂	mg/L	0	0	17
NO ₃	mg/L	6.5	9.4	34
SO ₄	mg/L	695	774	34
Na	mg/L	408	102	34
K	mg/L	692	165	34
Mg	mg/L	41	30	34
Ca	mg/L	371	120	34





Parameter	Unit	Average	Standard deviation	Number of samples
Si	mg/L	22.6	6.7	33
Fe	µg/L	34	53	33
Ni	µg/L	105	23	33
Cu	µg/L	50	87	33
Zn	µg/L	132	144	33

As stated above, during the very initial phase of operation of the precipitation system, the conditions applied (Table 35) delivered the targeted phosphorus removal of 80%. However, the supersaturation conditions were found to be too high which led to the very rapid formation of very small crystals which in turn led to a rapid scaling of the system. Significant scaling of the feed pump, located before the dosing points for Mg and NaOH, was also observed (Figure 98) which first highlighted the natural ability for precipitates to form in the feed water. Modifications were then made to the system in two phases in September and then October 2022. Some of the modifications were of a practical nature, for example the addition of a valve in the recirculation to allow to isolate specific sections of the system for ease of inspection of the pipe, dosing points and probes. Additional connections and pipes were added so that water can be recirculated from the feed tank through the reactor to provide the facility for in-situ cleaning. Also, as briefly mentioned above, it was decided to use the acid dosed AnMBR permeate as the feed to the demonstration units to avoid precipitate formation and scaling before the Mg and NaOH dosing points. Finally, the NaOH dosing point was moved closer to the entrance of the reactor to avoid scaling in the small section of pipe before, when the conditions have been adjusted for crystallisation. Also, the dosing points were modified to increase the velocity of the water, ensure high turbulences and avoid deposition.

Table 35. Operational parameters and performance of the precipitation unit during the initial phase of testing (September to November 2022).

Flow rate (m ³ /h)	Recirculation rate (m ³ /h)	Feed pH	Targeted Mg:P ratio	PO ₄ -P removal (%)
1	7	8.3	1.3:1	80
0.5	3.5	6.7	1:1	0-26
0.5	7	6.5-7	1:1	5-40
0.5	7	7.7-8.5	1:1	62-75

When the system was restarted, several conditions were tested (Table 35). To avoid rapid scaling, trials were initially conducted with no further pH adjustment and at the time the AnMBR displayed a pH between 6.5 and 6.7. Although, this pH is below the optimum range need for struvite crystallisation, some phosphorus removal and some small precipitates were observed in the reactor. The system was first tested with a recirculation rate of 7:1, to maintain the dilution between the fed and recirculation constant, but performance was generally poor with 0 to 26% phosphorus removal achieved. Increasing the recirculation rate to 14:1 helped increased the removal



efficiency to between 5 and 40%. This can be explained by a better mixing within the reactor allowing for a better reaction and more accumulation of the small particles formed into larger aggregates. Although these conditions are not suitable to achieve the target set for this technology, starting the system with more conservative conditions is found to help better control the supersaturation ratio and avoid very high values which are known to promote rapid nucleation but limit crystal growth. When the pH was further increased (7.7-8.5) in the typical range expected for struvite crystallisation, the phosphorus removal significantly increased to between 62 and 75%, demonstrating the potential to achieve the targeted recoveries. For these trials the Mg:P was targeted at 1:1. As the limiting factor of the reaction, it is often recommended to overdose Mg, hence the value of 1.3:1 reported in the literature. Since the feed concentrations in P and Mg vary over time and the additional dose of Mg is fixed, the ratio is expected to vary over time and could fall even below the 1:1. As the trials continue, more conditions will be tested to optimise the removal. At the later stages of these initial trials, after the modifications were made, the system was found to operate steadily. Also, in parallel, the data gathered from the initial trials is used to examine the changes in chemical equilibrium (using Visual Minteq) and supersaturation conditions to further inform the conditions to be tested.

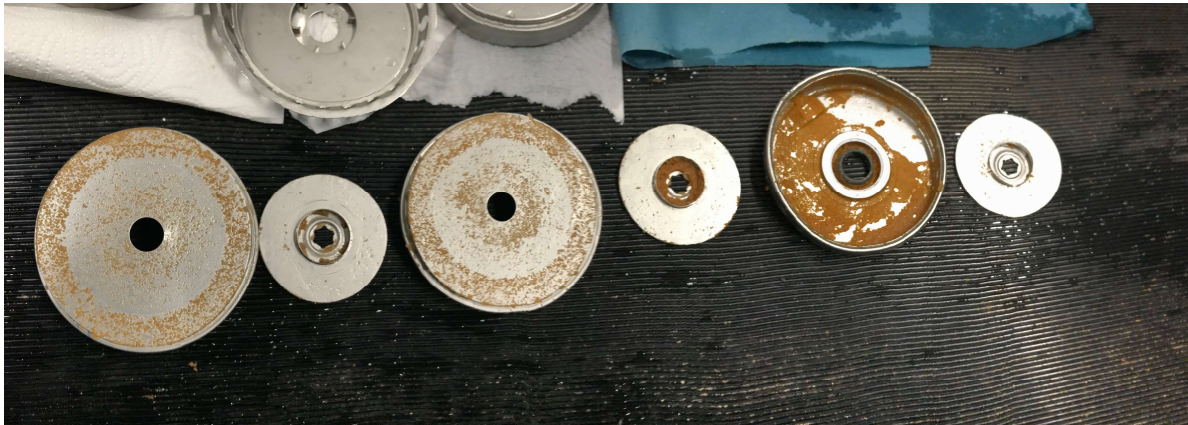

(a)



(b)



(c)



(d)

Figure 98. Scaling of the (a) internal part of the feed pump, (b) pipes, (c) chemical dosing points and (d) probes.

During these initial trials, samples of the precipitates formed were collected regularly. First, when collecting samples in the different sections of the reactor it was found, as expected, that the majority of the precipitates were present in the bottom sections (A and B) while the top sections had very little solids (Figure 99). This confirms that the stratification occurs in the reactor. The solids collected from section A (harvesting of the product) were then further analysed. During the very first phase with high pH and Mg:P ratio, pellets of 1.6-1.9 mm were formed (Figure 100). The images show that the pellets recovered are aggregates of smaller crystals demonstrating that the system works as expected. Interestingly, the pellets recovered in the later trials were mostly similar in size, although some larger particles were observed, but also looked to have a more polished surface (Figure 101). The main difference between the two sets of samples is that for the first one, the crystals would have been at most for a couple of days in the reactor while at the later stages, the crystals were kept for at least a week. This then shows that as the pellets are accumulating in the reactor, they rub against the walls of the reactor and each other and form smoother beads which is likely to influence the size of the product formed. Finally, the quality of the pellets recovered was analysed. The elemental analysis of the pellets demonstrated a high content in oxygen, phosphorus, nitrogen, and magnesium (Table 36), all components of the struvite molecule, suggesting that the product is indeed struvite. This was further confirmed by X-ray diffraction (XRD) as struvite was identified as the main component (Figure 102). The sharp peaks and very limited noise in the XRD spectra suggest that that product is of high quality. This is supported by the elemental analysis (Table 36) as number of other compounds were identified such as Ca, K, Na, Cl and Si but all at very low levels. Also, the organic content of the pellets was measured at only 0.6% by weight.

Trials so far have provided valuable experience and learnings from both design and operation point of views. Further trials will now be conducted to achieve more stable

operation and also achieve the targeted removal and recovery for the different compounds. The harvesting period will be studied to further investigate the impact on size and quality for the product formed.



Figure 99. Samples collected from the different sections of the reactor A to D, from bottom to top.

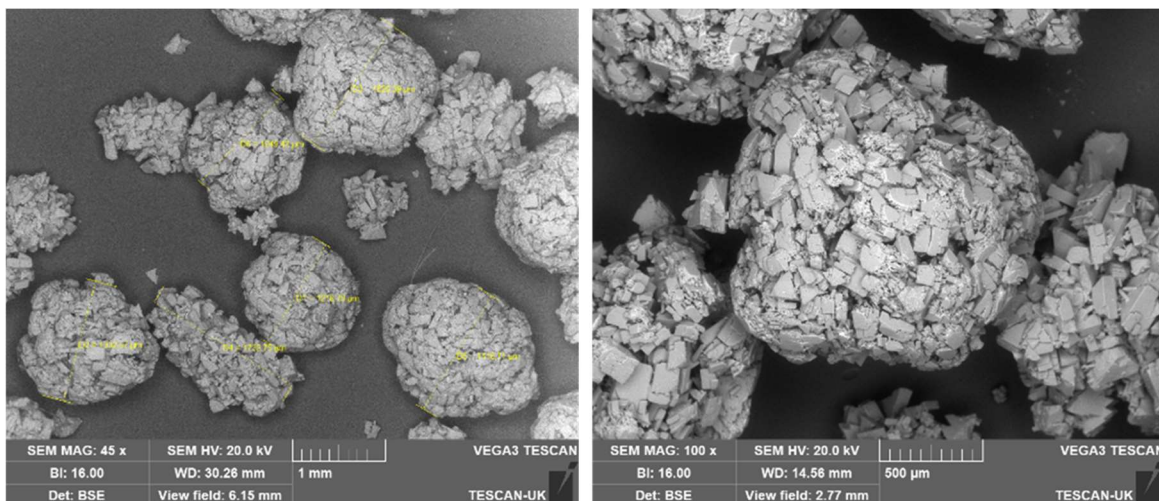

Figure 100. Scanning electron microscope images of the struvite pellets harvested after the first trial ($pH = 8.3$, $Mg:P 1.3:1$).

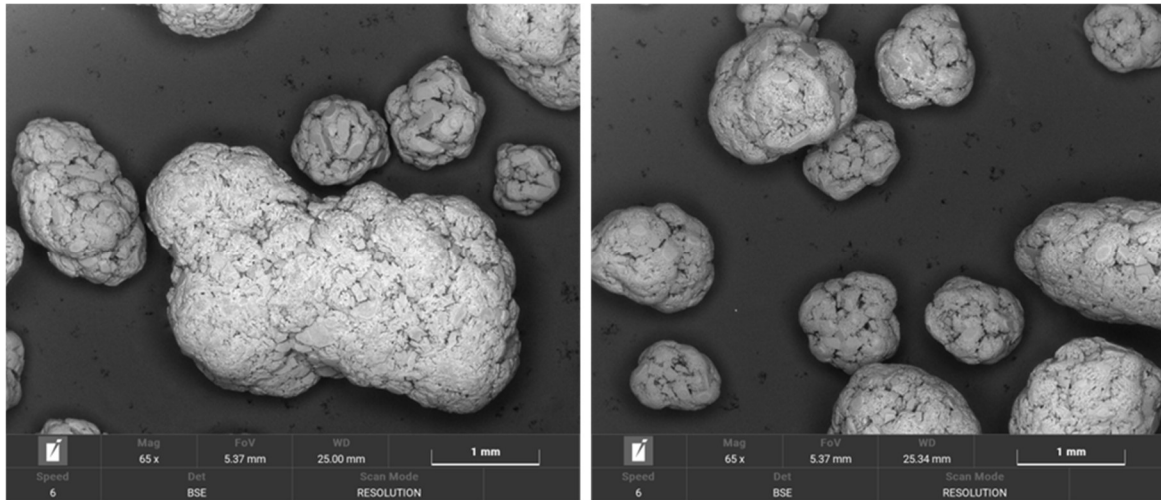

Figure 101. Scanning electron microscope images of the struvite pellets harvested in the later trial (pH = 7.7-8.5, Mg:P 1:1).

Table 36. Elemental analysis (as % weight) by Energy-dispersive X-ray spectroscopy (EDS) of selected areas on different pellets recovered from the reactor.

Element	Sp. 1	Sp. 2	Sp. 3	Sp. 4	Sp. 5	Sp. 6	Sp. 7	Sp. 8	Sp. 9	Sp. 10
C	5.35	11.98	11.13	7.71	6.4	3.75	2.55	6.83	2.04	4.32
N	7.04	6.28	6.72	6.98	6.94	6.99	6.66	4.2	6.31	6.91
O	64.53	60.8	62.26	64.32	66.33	67.46	69.07	53.27	64.03	67.23
Na	0.29	0.52	0.15	0.26	0.17	-	-	0.51	-	0.16
Mg	9.07	8.83	8.4	9.29	9.42	9.36	10.34	3.35	12.3	9.39
Al	-	-	-	-	-	-	-	0.32	-	-
Si	0.08	0.08	-	0.06	-	-	-	25.27	-	-
P	12.63	10.25	11.01	10.78	10.36	12.02	11.07	5.56	14.97	11.58
Cl	0.3	0.44	0.07	0.17	0.07	-	-	0.22	-	-
K	0.71	0.74	0.26	0.42	0.31	0.35	0.26	0.4	0.34	0.35
Ca	-	0.08	-	-	-	0.07	0.05	0.08	-	0.07
Total	100	100	100	100	100	100	100	100	100	100

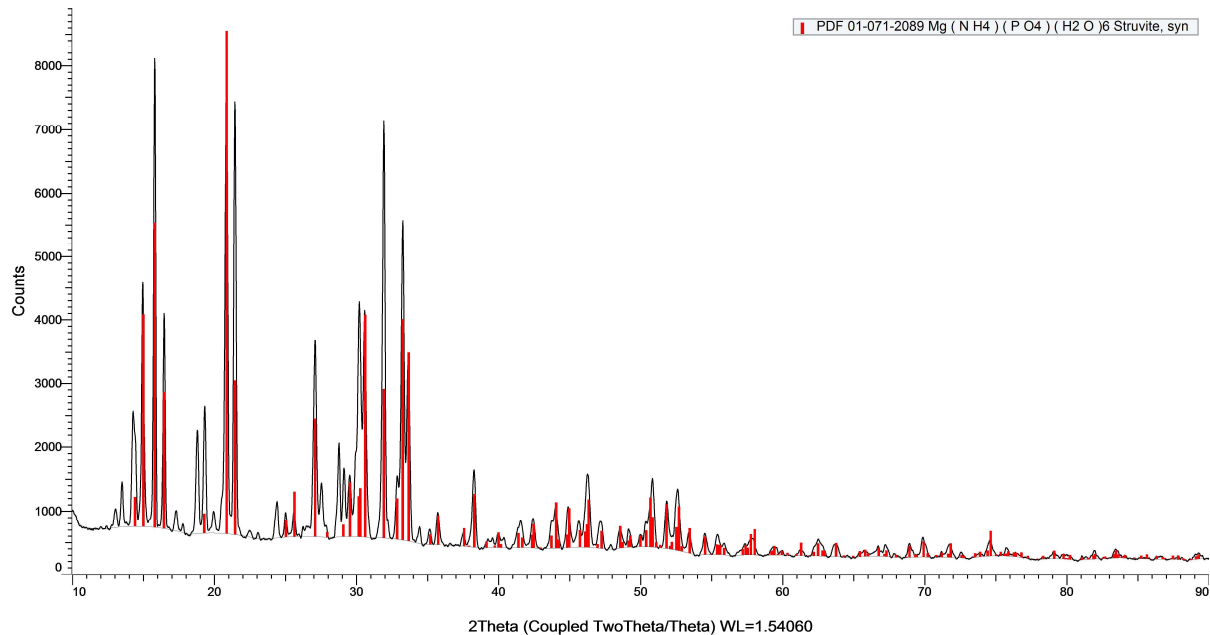

Figure 102. Example of X-ray diffraction spectrum for the pellets recovered from the reactor (black) matching closely the standard for struvite (red).

The stripping unit was operated to date only for a short period of time over 1 week. The system was fed by the effluent from the precipitation unit during the latest period reported above with concentrations of ammonia nitrogen of 833 ± 33 mg N/L, phosphate of 66 ± 2 mg P/L, Mg of 18 ± 3 mg/L and pH of 8.3 ± 0.1 . The pH was then adjusted to 10 (measured as 9.64 to 9.87 in the treated effluent). Over this test period, the stripping and scrubbing units operated stably and ammonia nitrogen removal of 77 to 80% were achieved. When using a fresh batch of sulfuric acid in the scrubber, the solution contained 10.2 g/L of ammonia nitrogen after just 24 hours. These results demonstrate not only the good removal but also the good recovery of the ammonia from the water. The acid solution sampled (pH ~ 1.9) also contained 681 mg/L of COD highlighting that some of the organics left in the wastewater after the AnMBR are volatile. Further analysis is being performed to better understand the quality of the product. The trial was conducted with no adjustment of the temperature, with the water at 22°C , reduced from an average of 32°C in the precipitation unit due to losses during the treatment. The stripping process can be optimised by adjusting both pH and temperature and this will be studied in the subsequent trials.

2.7.5. Case study main conclusions

Over August and September 2022, the different systems from Case Study 7 were installed and commissioned. These include struvite precipitation and stripping/scrubbing units for nutrients recovery, designed for a flow of $1 \text{ m}^3/\text{h}$, a reverse osmosis membrane system for water reuse with a design flow of $1 \text{ m}^3/\text{d}$, and heating systems at both scales to study residual heat utilisation. All units are operational but due to the complexity of the integration of all the systems to be studied, in this initial phase of the testing programme, our focus was mainly on the operation and optimisation of the nutrients recovery demonstration systems.

Several challenges were faced with the struvite precipitation with in particular severe scaling of the pumps and pipes before the reactor. These led to important learnings on





the design and operation of the reactor. After modifications were made to the system, steady operation was possible and phosphorus recoveries of about 70% were achieved. Importantly, struvite pellets of around 1 mm in diameter were harvested. Analysis for the product has confirmed its good quality with very little contamination with other compounds. Operation of the ammonia stripping and scrubbing units went well over the start-up period allowing to achieve ammonia removals of up to 80% and the production of an ammonia sulphate solution of high quality with a concentration of 10 g/L as ammonia nitrogen. Again, significant learnings were gained from these initial trials in terms of operation and in particular the impact of the pH of the feed water. The trials carried out over this start-up period have provided a strong base for further optimisation of these systems to achieve the targets set in this project (recoveries of 80% for phosphorus and 90% for ammonia).

The initial trials with the reverse osmosis membranes have confirmed the potential to produce high quality water for reuse but also opened some questions about the impact of the chemicals used for pH adjustment in the nutrients recovery stages on the operation of the membranes (higher salinity = higher pressure requirement). All systems have so far been tested with the natural residual heat from the anaerobic membrane bioreactor system but further trials at various temperatures in the different systems will help understand how the residual heat may help mitigate some of the challenges faced (e.g. higher temperature can help reduce flow resistance in membranes).

2.8. CS8 Chemical platform of Roussillon (France)

2.8.1. Brief description of the case study and objectives

The Roches-Roussillon chemical platform exists since 1915 and brings together 16 companies specialized in the chemical industry on the same site, including several giants of the sector such as Seqens, Elkem and Adisseo. SUEZ RR IWS Chemicals operate on this platform a) two hazardous waste incinerators that treat a significant proportion of the chemical platform waste and b) a biomass recovery unit that provides 15% of the chemical platform steam requirement.



Figure 103. The Roches-Roussillon chemical platform.





On Roches-Roussillon site, SUEZ RR IWS CHEMICALS activity focuses on three areas:

- Aqueris - High temperature incineration of industrial liquid hazardous waste, specialized in:
 - o Aqueous waste with strong salt content
 - o High sulphurous organic waste
 - o Very dangerous waste (cyanide, acetonitrile...)
- Aqueris - Evapo-incineration, for waste with a low pollutant load
- Robin - Hazardous and non-hazardous biomass valorisation, with steam production distributed to the platform industrials.

Among these plants, ULTIMATE project concerns the Aqueris incineration units. From 2015, the site has upgraded its incineration lines to broaden its range of waste acceptance. It is now able to dispose of very high sulphurous organic waste. The sulphur contained in the incineration flue gases is treated in dedicated scrubbers, and the scrubbing water is then treated in a wastewater treatment plant, in compliance with the regulatory limit values for atmospheric and aqueous emissions. To improve its environmental footprint and to continue its evolution towards waste recovery, SUEZ IWS CHEMICALS has set itself the objective of producing a secondary sulphur raw material from the waste treated in Aqueris incineration plant. The pilot plant installed through the ULTIMATE project aims to demonstrate its feasibility.

2.8.2. Technological solution in ULTIMATE project: pilot plant description

After an initial study, a selective absorption of sulphur (as sulphur dioxide) contained in the flue gas seems to be the most suitable way to achieve the recovery target set on the Aqueris unit.

The process implemented has two major objectives: to recover selectively a major part of sulphur dioxide contained in the incineration flue gas and to generate the selected recovered sulphurous product.

The schematic diagram of this process is described on Figure 104. This process involves the incineration flue gas treatment by a combination of two scrubbers. Sulphur dioxide is an acid gas, and, in our application, pH adjustment in the two columns will have a critical role. The second column, called *D 310*, is regulated at basic pH by a reagent. The absorption efficiency of sulphur dioxide is very good in this pH range, and this allows to recover a large part of sulphur contained in incineration flue gas. The formed solution feeds the first column, called *D 210*. This column is regulated at acid pH. Sulphur dioxide is then recovered to create the desired sulphurous product.



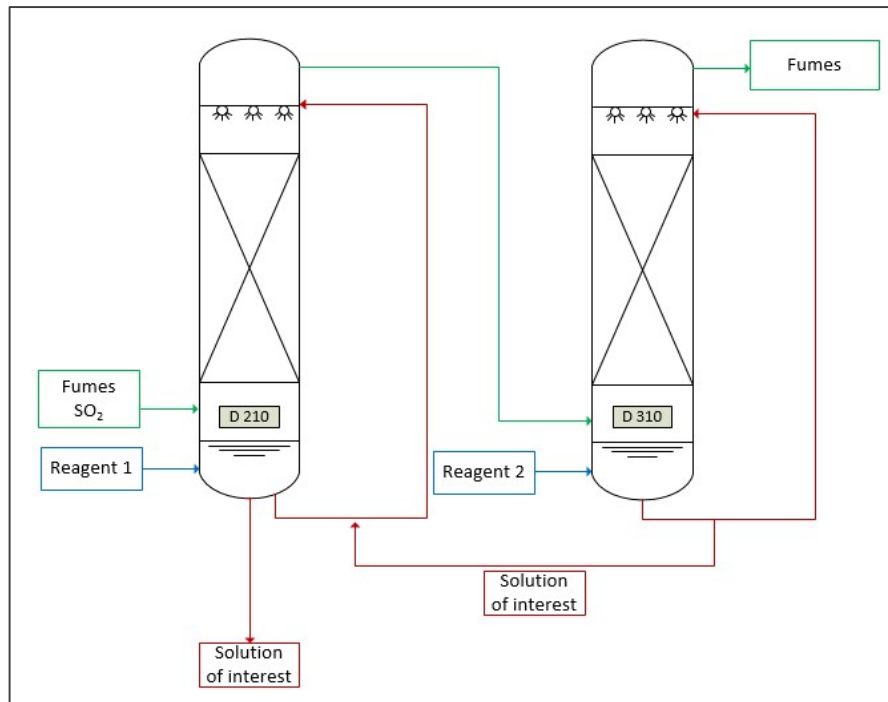

Figure 104. Principle of the industrial pilot.

This process seems suitable to the numerous constraints of Aqueris unit.

This pilot plant has been sized to treat about 500 Nm³/h of fumes. After realizing processes performance studies, some additional equipment has been added to obtain the desired results (heat exchanger upstream of the columns, storage tank for the recovered product, recirculation pumps, etc.). To realize long test run, this pilot plant will be semi-automatic. The instruments (automatic valves, control valves, continuous analysers) and controls required for proper and safe operation will be installed on the pilot. This pilot should be implanted in April 2023.

Meanwhile, a laboratory pilot was built, and it aims to realize a parametric study on a synthetic gas. The diagram of this pilot is described on Figure 105.



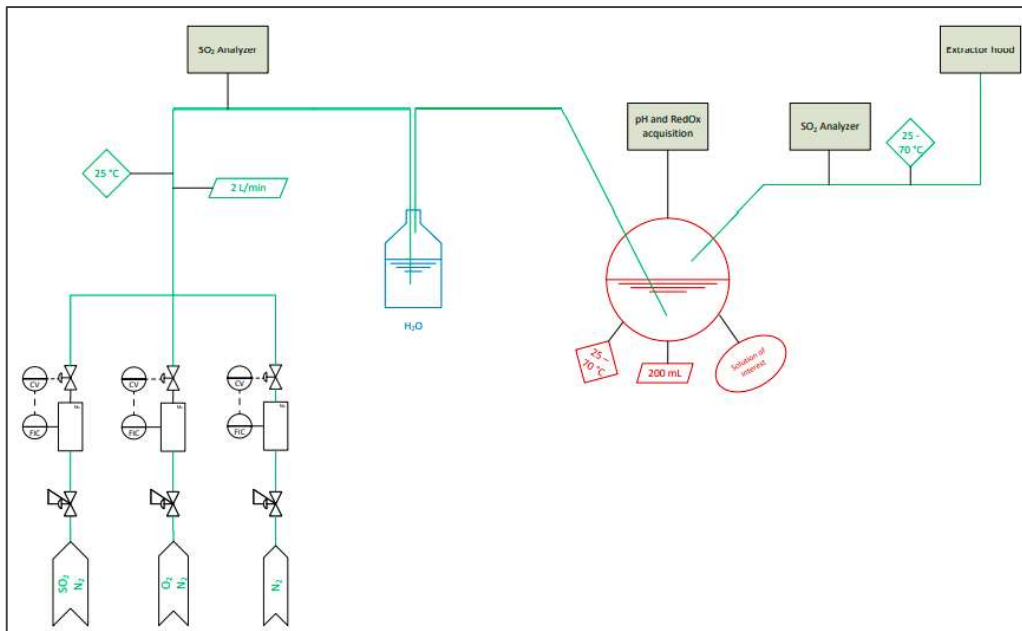

Figure 105. Diagram of the laboratory pilot.

A gas mixture is generated thanks to three bottles and mass flowmeter. This mixture bubbled through the absorption liquid in a flask of 200 mL. The gas comes out purified in sulphur dioxide.

The amount of sulphur dioxide in the gas is detected at the outlet by a flue gas analyser. An acquisition of pH value is operated continuously with a probe. Moreover, the liquid is analysed at regular intervals after syringe sampling by test kits.

2.8.3. Start-up operation

15 tests were carried out to study the impact of different parameters on sulphur dioxide absorption. The parameters studied are the percentage of sulphur dioxide in the gas (%_A to %_G), the concentration of the absorption solution (C_A to C_E) and the temperature (T_A to T_C).

The following table lists the studied parameters for each test performed.

Table 37. Tests carried out.
Initial concentration ranges from C_A to C_E; % SO₂ ranges from %_G to %_A; Temperature ranges from T_A to T_C

Test	Initial concentration of the absorption solution	% SO ₂ in the mixture gas	Temperature of the liquid
1	C _A	% _A	T _B
2	C _B	% _A	T _B
3	C _C	% _A	T _B
4	C _D	% _A	T _B
5	C _E	% _A	T _B
6	C _C	% _B	T _B





Test	Initial concentration of the absorption solution	% SO ₂ in the mixture gas	Temperature of the liquid
7	C _C	% _C	T _B
8	C _C	% _A	T _A
9	C _C	% _A	T _C
10	C _B	% _F	T _B
11	C _B	% _F	T _B
12	C _B	% _D	T _B
13	C _B	% _E	T _B
14	C _B	% _G	T _B
15	C _B	% _F	T _A

2.8.4. Results from pilot plant operation and discussion

Concentration of the absorption solution

The impact of the initial concentration of the absorption solution on the absorption efficiency of sulphur dioxide must be evaluated. Indeed, the risk is that a high concentration may inhibit the absorption of sulphur dioxide. The following figure deals with the evolution of the absorption efficiency as a function of time at different initial concentrations.

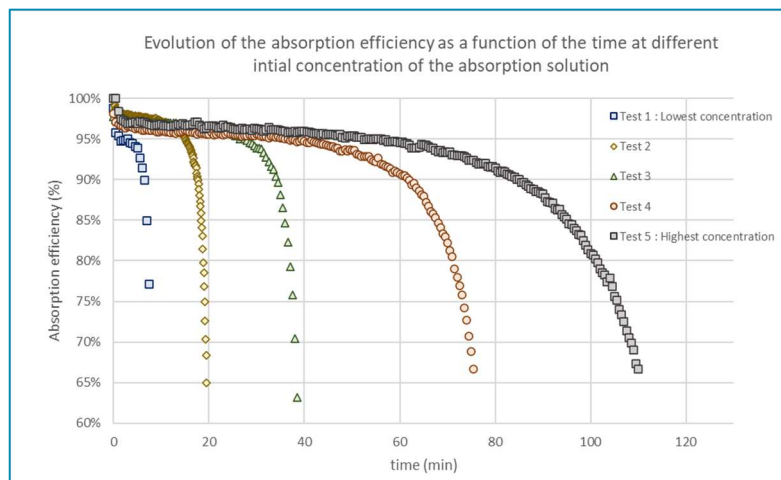

Figure 106. Evolution of the absorption efficiency as a function of the time

First, absorption efficiencies are good (> 95 %) before falling drastically once these yields reach a value of 90 % approximatively. The time involved to reach an absorption efficiency of 90 % are proportional to the initial concentration in the absorption solution. This result can be confirmed when these times are plotted as a function of the initial concentration (Figure 107). The regression curve obtained represents a straight line with a regression coefficient of 0.998. Thus, the initial concentration seems to have no impact on the absorption efficiency.



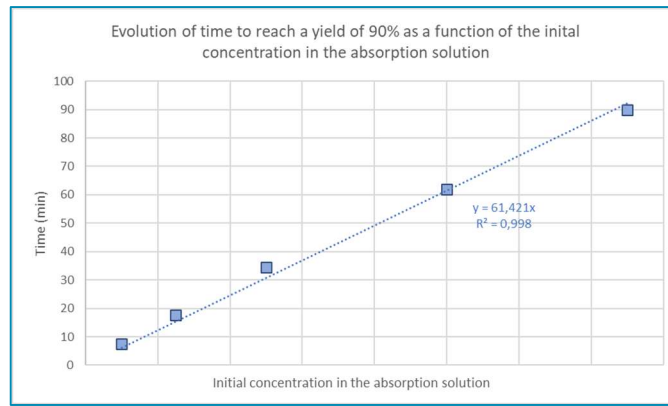

Figure 107. Evolution of time to reach an absorption efficiency of 90 % as a function of the initial concentration.

Thereafter, the absorption efficiency falls when the pH reaches a value near 5.5, and those for all concentrations tested. This affirmation can be observed in the next figure.

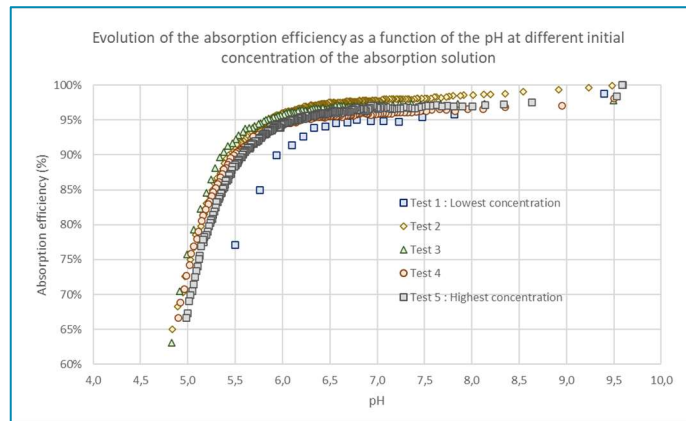

Figure 108. Evolution of the absorption efficiency as a function of the pH.

The yields are good over a pH range from 6.0 to 9.5 for all concentrations tested. The absorption is so promoted at basic pH. For acid pH values, the absorption efficiency varies greatly.





Percentage of sulphur dioxide in the incineration flue gas

The next figures deal with the evolution of absorption efficiency as a function of time with different percentage of sulphur dioxide for two different initial concentrations in the absorption solution.

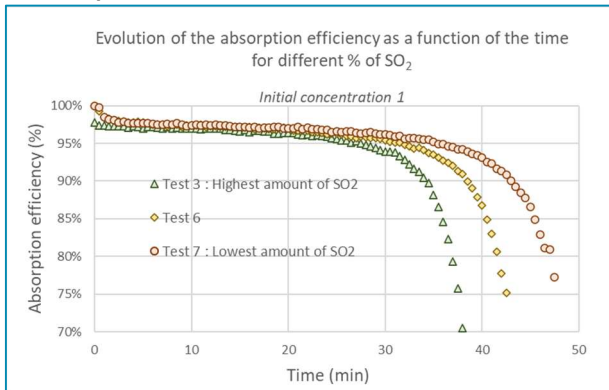

Figure 110. Evolution of the absorption efficiency as a function of the time for different percentage of SO₂ at the first concentration tested in the absorption liquid

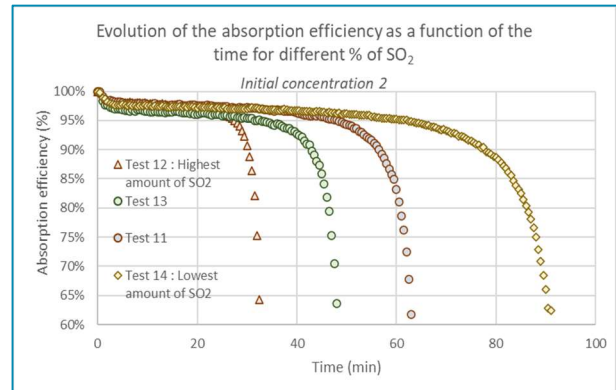

Figure 109. Evolution of the absorption efficiency as a function of the time for different percentage of SO₂ at the second concentration tested in the absorption liquid

Again, the absorption efficiencies are greater than 95 % before falling drastically. The percentage of sulphur dioxide has no effect on the absorption efficiency. In fact, for pH controlled around 5, the absorption efficiency is similar for any sulphur dioxide concentration in the gas (Figure 111 and Figure 112).

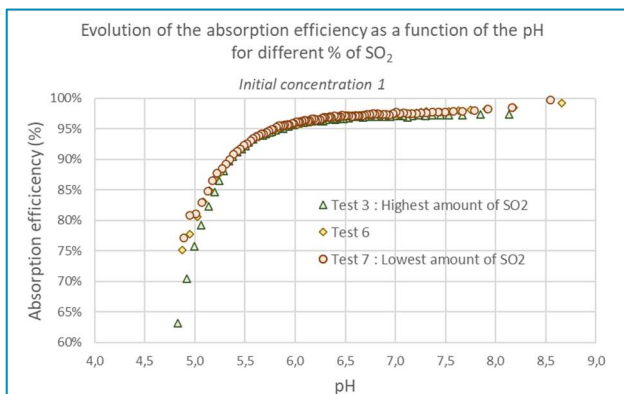

Figure 111. Evolution of the absorption efficiency as a function of pH for different percentage of SO₂ at the first concentration tested in the absorption liquid

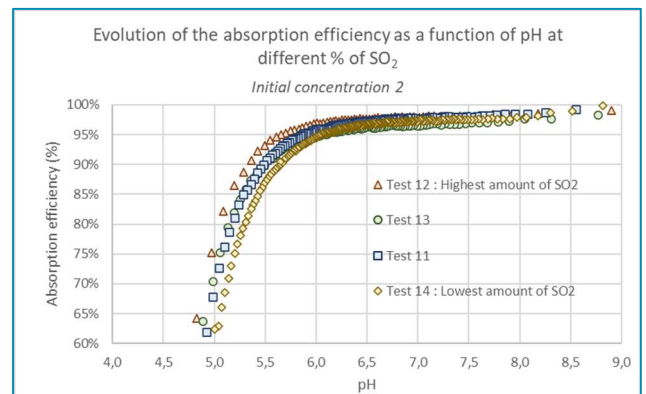

Figure 112. Evolution of the absorption efficiency as a function of pH for different percentage of SO₂ at the second concentration tested in the absorption liquid





Temperature

The temperature is an important parameter to study because it usually impacts the gas-liquid transfer phenomenon. The Figure 113 deals with the evolution of the absorption efficiency as a function of time at different temperatures. Absorption efficiency of sulphur dioxide seems to be better at low temperature. This is consistent with the literature: the mass transfer between gas and liquid phases is promoted at low temperatures.

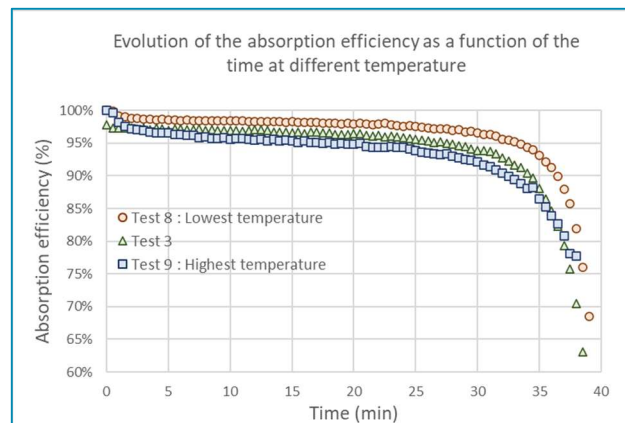

Figure 113. Evolution of the absorption efficiency as a function of the time at different temperature.

2.8.5. Case study main conclusions

The industrial pilot, designed to treat 500 Nm³/h of flue gas, isn't still operational. CS8 faced difficulties to find a supplier who understood our constraints and requirements and could technically and financially meet them.

The material selection for the industrial pilot was especially a challenge in that we must find the best compromise between chemical and thermal compatibility, durability, price and availability. In the meantime, we designed a laboratory pilot to start a parametric study.

Several parameters likely to have an impact on recovery yield and on product quality have been studied. Thus, absorption recovery doesn't seem to greatly depend on the absorption solution concentration and on the sulphur concentration in the flue gas. Concerning the temperature of the recovery process, it seems to impact the yield recovery and the product quality.

The delay in selecting a supplier for the industrial pilot construction allowed us to deal with the impact of this parameter in depth. We have so added to the industrial pilot design a preliminary cooling stage (with a water/gas exchanger), but also heating elements at key position in the industrial pilot to maintain the temperature through an adapted control system, because we supposed a high impact of temperature fluctuation on the product grade.





2.9. CS9 Kalundborg (Denmark)

2.9.1. Brief description of the case study and objectives

The Kalundborg Industrial Symbiosis Association exists since 1972 and interlinks thirteen private and public companies. The local industrial sector includes petrochemical, light building construction material, food, pharma, biotech, energy and bioenergy as well as waste processing. Different circular economy approaches for water, energy and materials are already implemented, e.g. the reuse of cooling water for steam production, the reuse of gypsum from exhaust gas cleaning to produce plasterboards, integrated heat management and the transfer between the industries and the district heating network as well as heat recovery from process water for district heating.

Even though, the Kalundborg Industrial Symbiosis already recovers and reuses certain materials, water and energy, there are still options to intensify and extend the circular economy related strategies. One aspect is the treatment of wastewaters, which is done by two companies Novozymes and Kalundborg Utility. ULTIMATE focuses on the optimisation of two WWTPs aiming at developing and implementing a joint control system for both plants, the recovery of the WWTP effluent as fit-for-purpose water, and to explore the potential for the recovery of valuable compounds from the industrial wastewater as well as on identifying options to reuse thermal energy recovered from wastewater. Therefore, the symbiotic relationship between Novozymes and Kalundborg Forsyning is extended in the frame of ULTIMATE to create a win-win situation for both.

2.9.2. Technological solution in ULTIMATE project: pilot plant description

ULTIMATE aims to produce fit-for-purpose water for an industrial reuse such as cooling or steam production. Furthermore, the feasibility of using the fit-for-purpose water for cleaning trucks or streets will be investigated. A typical treatment train for the production of such water is the combination of ultrafiltration (UF) or nanofiltration (NF) as pre-treatment for reverse osmosis (RO). This treatment trains are currently tested for the effluent from the secondary clarifiers of Kalundborg WWTP.

The municipal WWTP Kalundborg (mWWTP) treats different wastewaters: municipal wastewater, pre-treated industrial wastewater and wastewater resulting from a nearby power plant. The industrial wastewater contains a high fraction of non-degradable organic matter and contributes with approximate 50% to the total inlet flowrate of the WWTP. Thus, a large fraction of non-degradable organic matter also passes the mWWTP. In Figure 114, the effluent from the secondary clarifier of the mWWTP is shown. Besides the high contents of organic matter, also the high concentrations of calcium, hydrogen carbonate and sulphate are challenging for membrane processes. To prevent the RO from organic fouling and inorganic scaling, different UF and NF membranes are tested as pre-treatments (see for more details also section 2.9.3. *Start-up and operation of membrane pilot plants*).



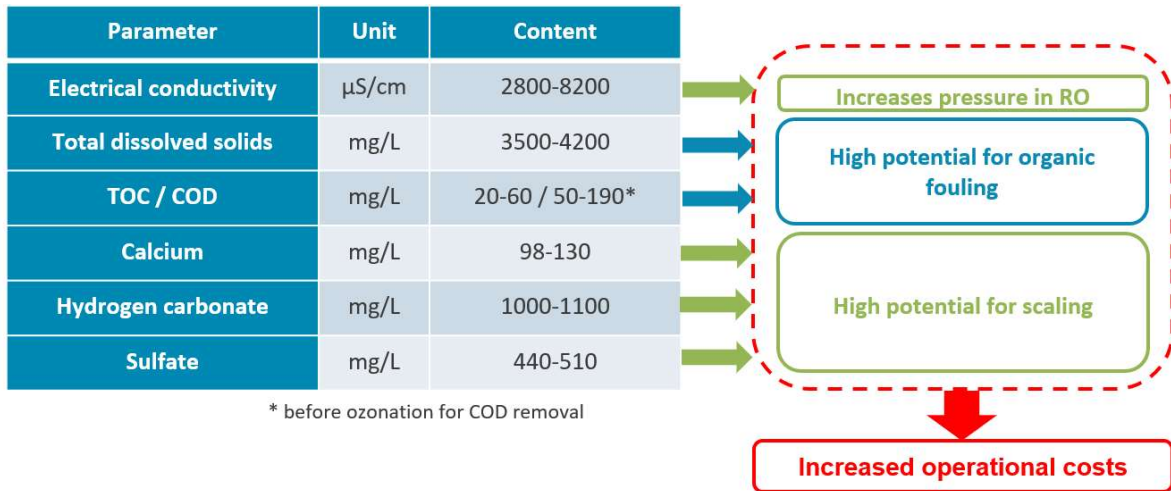

Figure 114. Composition of the outlet of the secondary clarifier of the municipal WWTP and upstream of the final ozonation unit.

In two parallel operated pilot plants (Figure 115), the following membranes were tested: a conventional ultrafiltration membrane (UF) with a molecular weight cut-off (MWCO) of 150 kDa, a novel ultra-tight UF membrane with an MWOC of 4 kDa, a conventional open nanofiltration membrane (NF) with a MWOC of 1 kDa followed by conventional reverse osmosis membranes.

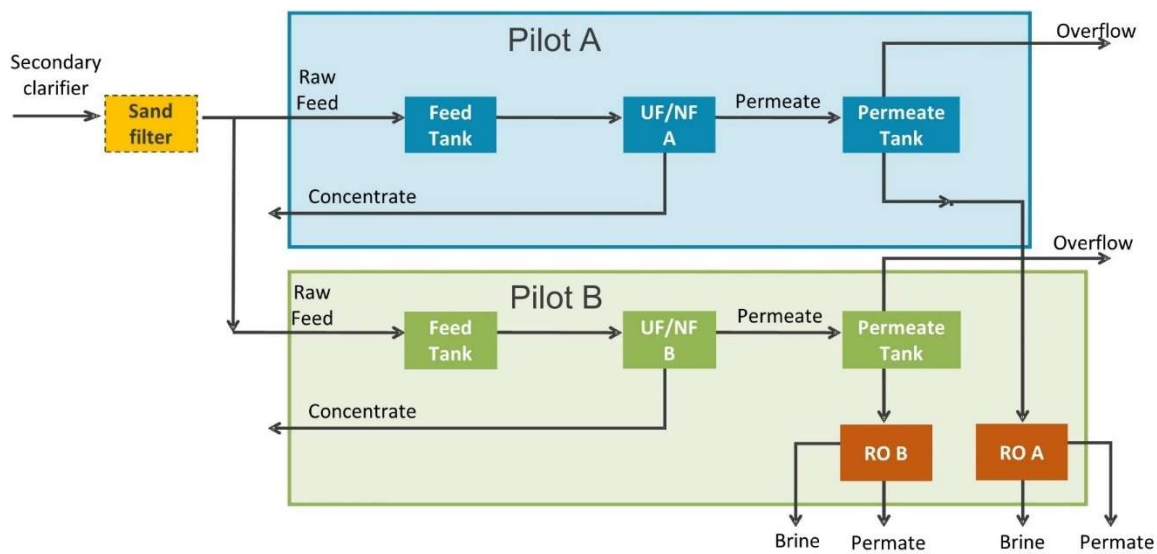

Figure 115. Pilot container A and B with pre-treatment, tanks, membrane units and water streams.

Figure 116 shows the two pilot plant containers with the membrane modules. The novel ultra-tight ultrafiltration membrane was developed using the Layer-by-Layer (LbL) technology and consists of hollow fibres with a diameter of 0.8 mm and filtrates from inside out. The materials of the fibres are polyvinylpyrrolidone and polyethersulfone. A module has a diameter of 0.2 m and is 1.5 m long, with a membrane area of 40 m².





Figure 116. Pilot A - left: conventional ultrafiltration module; Pilot B - middle: reverse osmosis units and right: novel UF/NF module.

2.9.3. Start-up and operation of membrane pilot plants

For the start-up of the pilot system, the feed water was taken directly from the outlet of the secondary clarifier (SC; without sand filter). To prevent the pilot units from clogging by small particles, a pre-filter unit (Amiad®) with a 300 µm screen and automatic flushing (every 4-5 minutes) was installed upstream of each feed tank. In the first period different treatment trains were tested as shown in Figure 117.

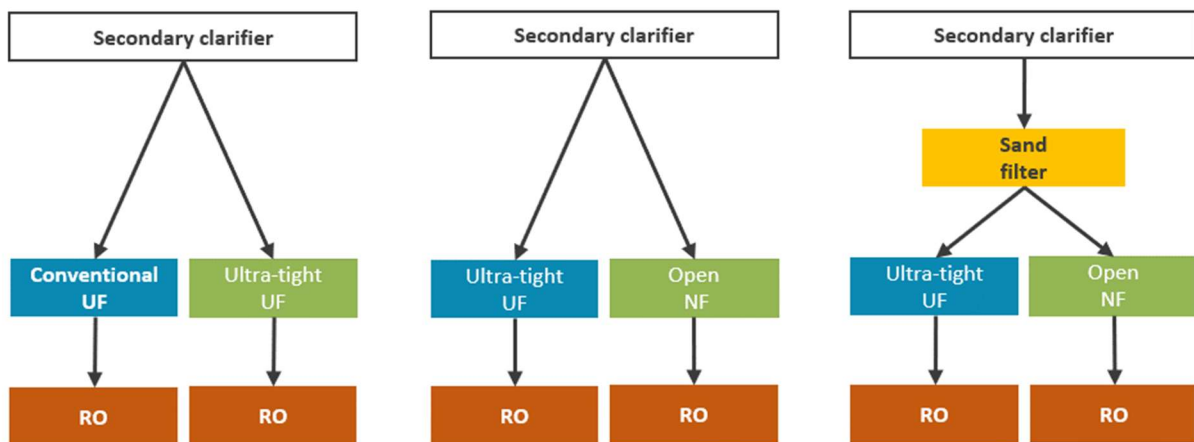

Figure 117. Tested treatment trains.

Conventional UF membrane

The operation of the conventional UF was started with a flux of 40-50 L/(m² h bar), a recovery of 65-85% and cross flow velocities between 0 m/s to 0.3 m/s. With the preferred settings a transmembrane pressure (TMP) of 0.05-0.4 bar was observed, depending on the state of the membrane (time since last CEB/CEC) and the feed water quality (Table 38).



Table 38. Tested operational parameter, preferred settings (bold) and measured TMP (for preferred settings).

Parameter	Unit	Conventional UF	ultra-tight UF	Conventional NF
MWOC	kDa	150	4	1
Flux	L/(m ² h bar)	30 – 40 – 50	15 – 20 – 25 – 30 – 32.5 – 35	15 – 20 – 22.5 – 25
Recovery	%	65 – 75 – 85	75 – 80	50 – 75
Cross flow velocity	m/s	0 – 0.15 – 0.25 – 0.3	0.3 – 0.4 – 0.5	0.3
TMP	bar	0.05 – 0.4*	0.25 – 2.0*	1.1 – 2.7*

* depending on feed water quality.

The first period of operation was characterised by many interruptions due to problems with a low permeability and blocking of the pre-filter unit. Two to three times per week manual cleanings of the pre-filter unit would have been necessary to keep the pilots running. The hydraulic cleaning of the UF membrane was carried out every 15-25 min and automatic chemical enhanced backwashes or chemical enhanced cleanings (CEB or CEC) were done one to three times per day (Table 39).

Table 39. Maintenance effort/trouble shooting for a continuous pilot plant operation.

Module	Cleanings, frequencies and trouble shooting
pre-filter unit of UF/NF without SF	manual cleaning: 2/week-3/week , many downtimes due to clogging
pre-filter unit of UF/NF with SF	manual cleaning: 1/(2 weeks)
Conventional UF membrane (without SF)	regular chemical cleaning (CEB/CEC): 1/day- 3/day , low permeability => additional chemical cleaning (with extended circulation/soaking time, with additional chemical dosing), manual CIP necessary, change to citric acid
Ultra-tight UF/NF	regular chemical cleaning (CEB/CEC): 1/day , depending on the feed water quality additional chemical cleaning (with extended circulation/soaking time, with additional chemical dosing)
RO (pre-treatment: UF/NF, without SF)	discontinuous operation possible only, due to downtimes of UF/NF and correspondingly, too little water production for the downstream RO unit
RO (pre-treatment: SF + UF/NF)	continuous operation possible, manual CIP: 1/(2 weeks)





Because of a too low feed water production by the UF, the operation of the RO units was interrupted many times. Hence, the UF/NF membranes as pre-treatment can hardly be compared for this period.

Extra chemical cleanings or cleanings in place (CIP) did not increase the permeability. Only the exchange of HCl as cleaning agent to citric acid increased the permeability and led to a more continuous operation.

Coagulant dosing with different dosing rates upstream of the UF was also tested (0.5-3 mg/L Fe). However, this did neither increase the flux nor enhance the retention of any dissolved compounds, so the dosing of the coagulant was stopped. The possible benefit of coagulation on long-term fouling could not be assessed due to too many interruptions and changes in operation.

The conventional UF could not improve the water quality to a satisfying result as pre-treatment for RO. Also, the flux did not reach the expected values for UF. Only with a flux of 40 L/m² h bar, a recovery of up to 85%, a cross flow velocity of 0.3 m/s and cleanings with citric acid, a continuous operation was reached. Based on this result, the conventional UF membrane was exchanged with a commercially available nanofiltration membrane for further testing.

Novel ultra-tight UF membrane

The ultra-tight UF membrane was operated with a flux of 20-25 L/(m² h bar). Furthermore, a flux of 30 L/(m² h bar) was shortly reached, however, it could not be maintained in the long term. A recovery of 75-80% and a cross flow velocity of 0.3-0.5 m/s were successfully tested. With these settings most of the time a continuous operation could be ensured. A TMP of 0.25-2.0 bar was observed, depending on the state of the membrane (time since last CEB/CEC) and the feed water quality (see Table 38). The interruptions were generated by the blocked pre-filter unit or by the malfunction of the pre-filter unit and other plant parts.

The dosing of coagulant did not improve the operation of the membrane or the retention of water compounds.

Open NF membrane

The open NF membrane was operated with a flux of 15-25 L/(m² h bar). A recovery of 50-75% and a cross flow velocity of 0.3 m/s were tested.

The first weeks were characterised by interruptions due to different failures of the pilot plant and pre-filter unit blocking. But after this time with the preferred settings a continuous operation could be ensured. With the preferred settings a TMP of 1.1-2.7 bar was observed, depending on the feed water quality. Dosing of coagulant has not yet been tested.

Installation of sand filter

The operation of both treatment trains was characterised by many downtimes related to the pre-filtration unit, so that finally a continuously operated sand filter (SF) was implemented upstream of the treatment train. The sand filter removed the fine organic particles most likely originating from the biotech industry and improved the operation of both pilots, so that also the continuous operation of the ROs was possible.

After the implementation of the sand filter as pre-treatment, the number of manual cleanings regarding the pre-filter unit of the UF/NF was reduced to once per week





(Table 39). With these reduced downtimes, the UF/NF produced enough permeate as feed water for the ROs for a continuous operation. Currently, the operational data are evaluated according to the different pre-treatments. First results show a better operation with the open NF membrane upstream to the RO unit.

In this context, it is important to note, that the effort for maintenance refers to the pilot plant only. For a full-scale system, the maintenance will be different. However, the results for the pilot plants provide important hints for the full-scale system.

Granular media filtration as pre-treatment before UF/NF is normally not used. Only in case a granular media filter is built for other reasons, such as the protection of the Baltic Sea or the implementation of the revised urban wastewater directive, its implementation might be considered. Nevertheless, for an upscaling of the system, the pre-filter for the UF/NF has to be redesigned and built with a higher degree of automatisisation and redundancy.

2.9.4. Laboratory results from pilot plant operation and discussion

Regarding the quality of the fit-for-purpose water, different parameters were determined in the feed stream to the different membrane types and in their permeate streams. Furthermore, based on the results, the retention for the different water quality parameters were calculated and are shown in Figure 118 and Figure 119 for the conventional UF, the novel UF, the NF and RO units. Hereby, it should be noted, that all data, independent from the operational parameters of the pilot plant, were used to calculate the retention of the selected parameters for one membrane.

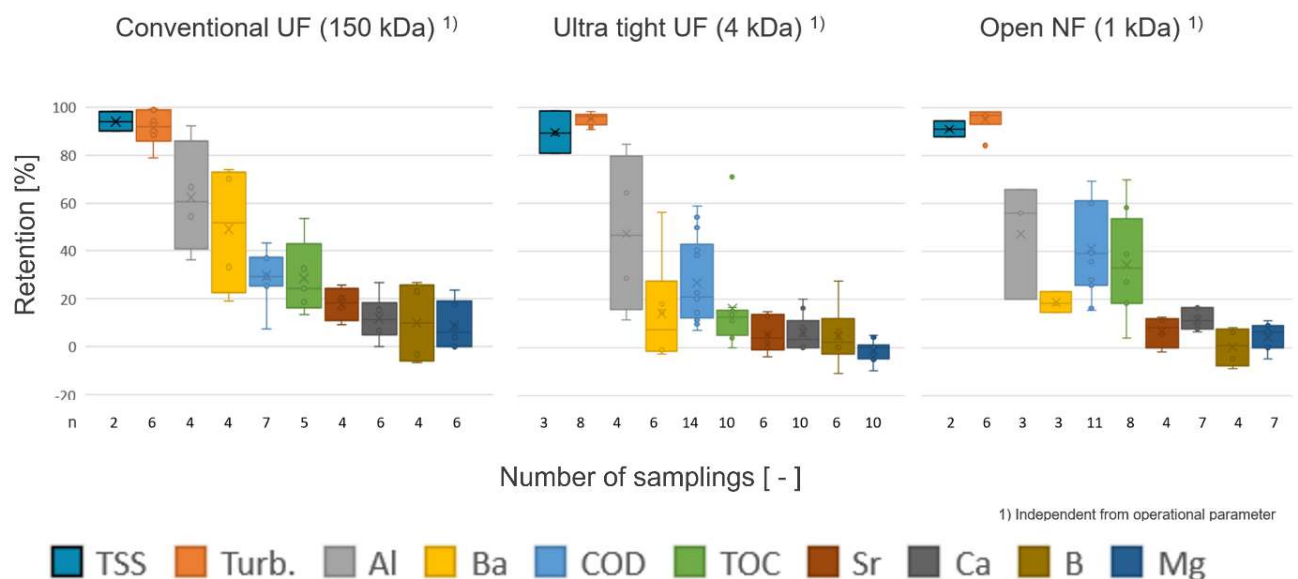

Figure 118. Retention of selected water quality parameters using different membrane types.

2.9.4.1. Retention of selected parameters per type of membrane

Figure 118 indicates that the open NF retains more organic matter (measured as COD and TOC) with around 40% compared to the conventional UF and the ultra-tight UF, with around 30% and 20%, respectively. The retention capacities for total suspended solids (TSS), the turbidity, aluminum (Al), strontium (Sr), calcium (Ca), boron (B) and magnesium (Mg) are on similar levels for all membrane types. It should be noted, that the used database is still quite small for some parameters and for which sometimes





their variation high in addition. This results in a wide range for the retention of some parameters.

In Figure 119, all data for both RO membranes were used to calculate the retention of the shown parameters, independent from their operational parameters and pre-treatment. As expected, the RO membranes show a high removal rate of many dissolved compounds, they retain the total hardness, calcium, sulphate and magnesium almost completely (> 99%). The ROs retain more than 98% of silica and more than 97% of the total dissolved solids, total organic carbon and dissolved ions (measured as electrical conductivity). The retention of the dissolved organic matter is higher than 94%.

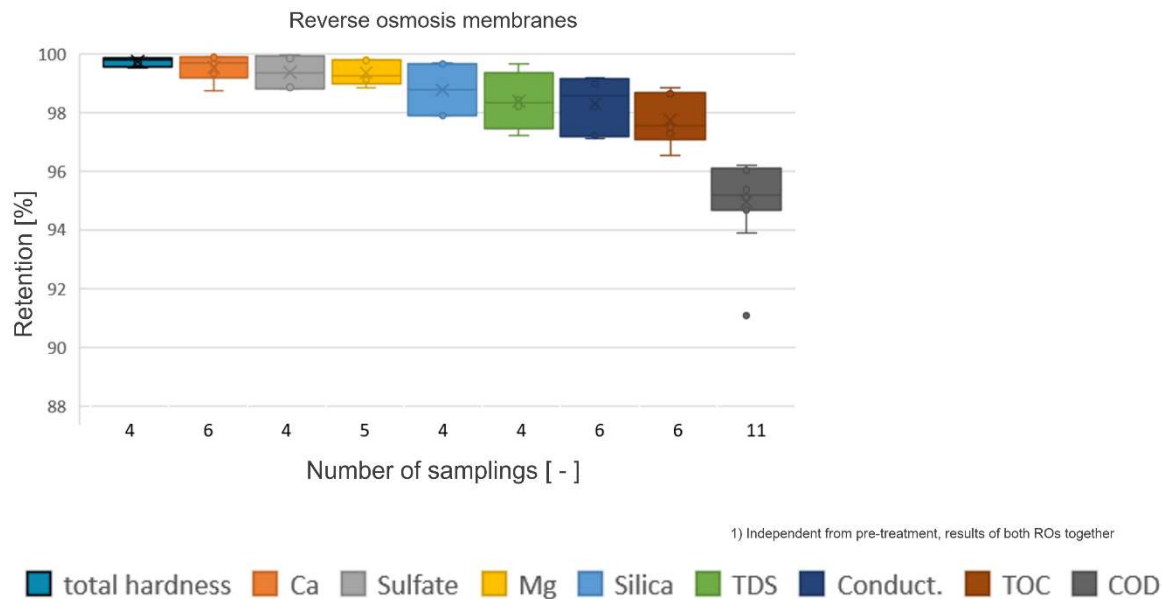

Figure 119. Retention of different water quality parameters using reverse osmosis.

2.9.4.2. Comparison of fit-for-purpose water qualities with requirements for cooling water

Regarding the different water qualities resulting from each membrane type, Table 40 presents the concentrations of the selected parameters compared to the requirements for cooling water. In particular, Table 40 shows average values obtained in the permeate streams from the conventional UF with 150 kDa, the ultra-tight UF with 4 kDa and the open NF with 1 kDa. The values used are independent of the operational parameters, because the data amount is still too low for a separate and more detailed evaluation. In the column “n” the number of analyses is shown. For the average concentrations of the selected parameters in the permeate after RO treatment, the available data of both ROs were used, also without any further differentiation referring operational parameters due to a low availability of data for a separate evaluation. Currently, the water from lake Tissø is used to produce cooling water.

As shown in Table 40, the treatment via UF and open NF membranes alone cannot reach the cooling water quality. However, the analysis of the first sample showed the retention of microorganisms such as *Escherichia coli* and *Legionella*. The downstream RO membranes reduce the electrical conductivity to levels lower than the currently used water and nearly all parameters reach the quality that is required for cooling





water. Only the pH and the calcium concentration are too low. Therefore, a typical post-treatment for RO permeate such as chemical stabilisation can be used to meet the requirements for cooling water and to prevent corrosion in the water distribution system





Table 40. Different water qualities after the treatment with different membrane types: conventional UF (UF), ultra-tight UF, open NF and RO compared to the required quality for cooling water according to RD1620/2007; VDI 3803 and Demoware D1.3 (Niewersch et al. 2016).

Parameter	Unit	Goal: cooling tower	UF 150 kDa ¹⁾	n	Ultra tight UF 4 kDa ¹⁾	n	open NF 1 kDa ¹⁾	n	RO ²⁾	n
Aluminium	µg/L	<500	< 30 ✓	4	38 ✓	6	< 30 ✓	3	✓	
Calcium	mg/L	> 20 / <500	127 ✓	6	135 ✓	12	140 ✓	7	< 0,5	6
Carbon. hardness	°dH	< 4 / < 20	26	2	29	4	33	3	0,13 ✓	6
Chloride	mg/L	< 50 / <250			1100	1	1000	1	19 ✓	7
Copper	µg/L	< 500			1,1 ✓	1	0,6 ✓	1	2,6 ✓	7
Conductivity	µS/cm	50 - <3000	5030	6	5200	8	5040	7	69 ✓	10
Iron	mg/L	< 0,1 / < 0,5			< 0,05 ✓	1	< 0,05 ✓	1	< 0,05 ✓	7
Magnesium	mg/L	<100	28,17 ✓	6	24 ✓	12	21 ✓	7	0,17 ✓	5
pH		7 - 9	8,2 ✓	2	8,2 ✓	5	8,1 ✓	4	6,4	10
Sulphate	mg/L	< 50 / < 600	498 ✓	4	437 ✓	10	337 ✓	6	2,0 ✓	6
TDS	g/L	<1,8	3,0	2	3,2	3	2,9	3	0,05 ✓	4
Total hardness	°dH	0,1 - <8	26	2	23	4	24	3	< 0,1 ✓	6
TSS	mg/L	<5	1,2 ✓	2	0,6 ✓	3	3,9 ✓	3	1,6 ✓	4
Turbidity	FNU	< 1	1,4	6	0,39 ✓	10	< 0,1 ✓	6	✓	
<i>Escherichia coli</i>	MPN/100 mL	Absence			< 2 ✓	1	< 2 ✓	1	✓	
<i>Legionella</i>	CFU/L	< 100			< 10 ✓	1	< 10 ✓	1	✓	

- 1) Independent from operational parameter
- 2) Independent from pre-treatment, results of both ROs together
- 3) Only one grab sample, currently reuse water quality
- 4) Only one grab sample, drinking water quality





2.9.4.3. Comparison of fit-for-purpose water qualities with requirements for steam production

Table 41 shows the average concentrations for typical parameters that are relevant for steam production, in comparison with the technical requirements. Again, the average concentrations are shown for each permeate resulting from the conventional UF with 150 kDa, ultra-tight UF with 4 kDa and open NF with 1 kDa as well as from the RO. Also, here the values are evaluated independent from any operational parameters due to the still low availability of data. In the column “n” the number of analyses is shown.

As shown in Table 41, the permeate resulting from the conventional UF membrane does not comply with any of the requirements for steam production besides the pH value. The permeates resulting from the tight UF and the open NF reach the required concentration ranges for some of the parameters such as clarity, copper, oil/fat, iron and the pH. After RO treatment, even the concentrations of COD, TOC and total hardness comply with the requirements for steam production in addition. However now, the pH is too low and the electrical conductivity as well as the concentrations of sodium, potassium and silicate are still too high. Hence, the water quality for steam production cannot be reached with the setting of the pilot plant alone. Therefore, a post-treatment for the RO permeate such as ion exchange is required to decrease the concentrations of sodium, potassium and silicate as well as the electrical conductivity. This treatment stage most likely is anyhow already present at the industries using steam. Thus, the challenge here is the possible chemical stabilisation for supply of water to industries as this slightly increases also the hardness.





Table 41. Different water qualities after the treatment with different membrane types: conventional UF (UF), ultra-tight UF, open NF and RO compared to the required quality for steam production according to EN-12952-12, boiler feed water.

Parameter	Unit	Goal: steam production	UF 150 kDa ¹⁾	n	Ultra tight UF 4 kDa ¹⁾	n	open NF 1 kDa ¹⁾	n	RO ²⁾	n
Alkalinity	mmol/L	0.5-15	18	2	15	4	16	3	0,2	✓ 7
Clarity		clear, free from particles	6/7		13/13	✓	8/8	✓	10/10	✓
COD	mg/L	3-5	61	7	55	16	42	11	< 5	(✓) 12
Copper	µg/L	< 3 - < 100			1,1	✓ 1	0,6	✓ 1	2,6	✓ 7
Conductivity	µS/cm	≤ 30/ > 30 *	5030	6	5200	8	5040	7	69	10
Oil and fat	mg/L	< 1 / < 0.5			< 0,1	✓ 1	< 0,1	✓ 1		✓
Iron	mg/L	< 0.01 - < 0,3			< 0,05	✓ 1	< 0,05	✓ 1	< 0,05	✓ 7
Sodium	mg/L	< 0.01 (Na+K)			890	1	870	1	15	7
pH		> 7.0 / > 9.2 / 7-10	8,2	✓ 2	8,2	✓ 5	8,1	✓ 4	6,4	10
Potassium	mg/L	< 0.01 (Na+K)			210	1	200	1	3,8	7
Silicate	mg/L	< 0,02	7,9	4	8,6	8	9,1	5	0,09 **	7
TOC	mg/L	< 0.2 - < 0.5	25	6	23	11	17	8	0,46	✓ 7
Total hardness	°dH	< 0,028 - < 0,28	26	2	23	4	24	3	< 0,1	✓ 6

* very wide range, depending on the type of vessel

- 1) Independent from operational parameter
- 2) Independent from pre-treatment, results of both ROs together
- 3) Only one grab sample, currently reuse water quality
- 4) Only one grab sample, drinking water quality

** 4/7 samples < LOQ (< 0,02)





2.9.5. Case study main conclusions

The membrane pilot plants are operating since 18 months treating roughly 50-100 m³/d, which results in a permeate production of about 10 m³/d. Their point of application is in the secondary effluent of a municipal wastewater treatment plant, which treats roughly 50% municipal wastewater and 50% pre-treated pharmaceutical and biotech wastewater. Due to the industrial wastewater, the composition of the secondary effluent contains a high fraction of non-degradable organic compounds and is quite challenging for the pilot plants.

Until now, different configurations were tested such as the combination of a pre-filter and conventional UF with a RO, the combination of a pre-filter and ultra-tight UF with a RO and the combination of a pre-filter and an open NF with a RO. In addition, the two last treatment trains were tested with and without a sand filter upfront to the pre-filter.

After the sand filter implementation, the necessary number of manual cleanings regarding the pre-filter unit was reduced. The sand filter removed the fine organic particles most likely originating from the biotech industry and improved the operation of both pilots. With these reduced downtimes, the UF/NF produced enough permeate as feed water for the ROs for a continuous operation. First results show a better operation with the open NF membrane upstream to the RO unit.

In this context, it is important to note, that the effort for maintenance refers to the pilot plant only. For a full-scale system, the maintenance will be different. In this case, the pre-filter for the UF/NF has to be redesigned and built with redundancy. Furthermore, in the case, a granular media filter is built for other reasons, such as the protection of the Baltic Sea or the implementation of the revised urban wastewater directive, its implementation might be considered and would be a good option. Hence, the results for the pilot plants provide important hints for the full-scale system.

The treatment via UF and open NF membranes alone cannot reach the cooling water quality. However, the first results showed the effective retention of microorganisms such as *Escherichia coli* and *Legionella*. After RO treatment, nearly all parameters reached the quality that is required for cooling water. Only the pH and the calcium concentration are too low. Therefore, a typical post-treatment for RO permeate such as a chemical stabilization can be used to meet the requirements for cooling water and to prevent corrosion in the water distribution system.

The water quality for steam production cannot be reached with the current setting of the pilot plant alone. A post-treatment for the RO permeate such as an ion exchanger is required to decrease the concentrations of sodium, potassium and silicate as well as the electrical conductivity. This treatment stage most likely is anyhow already present at the industries using steam. Thus, the challenge here is the possible chemical stabilization for the supply of water to the industries as this slightly increases also the hardness.

In the next months, the impact of the ultra-tight UF and the open NF on the RO operation will be investigated including a cross-evaluation of potential savings regarding chemical cleanings and exchange of membranes, obtaining higher flux and recovery rates as well as less flushing cycles, etc. on the RO side against additional operational efforts and costs on the UF/NF side. Because the continuous sand filter





does not perform according to expectations, it will be exchanged by a common dual media filter and extended by a coagulant dosing in front of these filters

3. Conclusions

ULTIMATE aims to establish and foster water smart industrial symbiosis by implementing circular economy solutions for water, material and energy recovery. The circular economy solutions shall create a win-win situation for both the water sector and the industry. In nine case studies the water sector forms those symbiosis with companies from the agro-food, beverage, petrochemical, chemical and biotech industry.

Each case study can be focused on closing the loops of water, energy and material/nutrients recovery. Depending on the topics each case study is involved in, pilot plants with different technologies have been designed and built to conduct trials in the industrial partners facilities. D1.9 focuses on the pilot plants developed and demonstrated in the frame of ULTIMATE until November 2022. In this chapter, the main conclusions from each case study experimental results are collected.

Through to the experimental work carried out so far in the different case studies, both at laboratory and pilot plant scale, general conclusions and several common lessons learned can be drawn:

1. **Preliminary work.** The design and construction of the pilot plant has required, for some case studies, preliminary work characterizing wastewater or by-products as starting point.

On the other hand, initial technology assessment at laboratory scale can provide very helpful information to scale up it at pilot plant scale. In several case studies, initial trials at laboratory scale were conducted to determine optimal operation conditions. In some cases, the experiments initially were performed with synthetic water and subsequently repeated with real water to obtain more realistic results. This information was used subsequently for the pilot plant design.

2. **Challenges of pilot plant design and construction.** In this phase, most of the case studies have had to transfer the technical requirements and specifications of the pilot plants to external companies, usually engineering or technology providers for the pilot plant design and construction. Sometimes, technical requirements are not standard, and providers have to understand and adapt their technologies and processes to the needs of the research tasks.

On the other hand, in some case studies, the pilot plant has been designed and built by two or more suppliers, which can hinder the coordination tasks necessary for the complete construction of the pilot plant. Furthermore, in some cases, a multi-sectorial expertise team has been built in order to get a comprehensive industrial design.

Finally, some case studies had to face up more challenges by designing and building two or more pilot plants to evaluate all the technologies required to recover water, energy and/or materials. Design two or more pilot plants normally





translate not only into more workload but higher risks about delays and difficulties to manage logistics and start-up operation.

In most of the case studies there were substantial delays with the construction for different reasons, some of them external to the case studies management: Covid-19 restrictions and subsequent delays with delivery of components (i.e. electrical and electronic material and devices supply).

3. **Experience from pilot plant commissioning and start-up.** Once the pilot plant is installed at the industrial partner facilities, start-up operation can begin. Main difficulties faced during the start-up and operation of the pilot plants were the malfunctioning of some equipment and instrumentation, that sometimes, required the adaptation or redesign of some part of the pilot plant.

Other kind of problems that appeared in the start-up and first days of pilot plants operation were related to water leaks and electrical safety aspects.

4. **Pilot plants current status.** Most of the case studies have their pilot plants in operation at the deliverable submission date, but not all the case studies can present preliminary plant operation results due to delays in pilot plant construction and commissioning or problems during the start-up operation. Instead, laboratory scale results are presented and discussed.

- In **Case Study 1 (Tarragona, Spain)**, a 12 m³/day pilot plant is currently in operation, including the following technologies: ultrafiltration, reverse osmosis, membrane distillation and adsorption on zeolites. For the design and construction of the pilot plant, two different suppliers were needed, and this, translated in extra difficulties in coordinating the assembly, logistics and start-up operation. Pilot plant commissioning was done in November 2022, and for this reason, preliminary results are not available to be included in this deliverable. Instead of this, laboratory results for the four technologies are included in this report.
- **Case Study 2 (Nieuw Prinseland, Netherlands)** the pilot plant for water and nutrient recovery was realised. The solution uses capacitive electrodialysis as a means of separation and is able to treat 0.1m³/day. The system has been commissioned and calibrated in the laboratory by performing control experiments and is ready to be moved to the case study site. No major problems were encountered during commissioning and start-up, but updates of the potentiostat that generates the voltages over the membranes, was required to provide a higher capacity. Also, small redesign of the membrane stack was required, as the used material has proven to be too fragile, leading to crack and leakage.
- In **Case Study 3 (Rosignano, Italy)** the adsorption pilot-system, put in operation in July 2022, has been realized with the scope to test alternative adsorbent materials to replace GAC during wastewater treatment, and to investigate the use of innovative sensors based on fluorescence and UV absorbance spectroscopy (UV₂₅₄ sensor) for process control and monitoring the breakthrough curves of organic material and organic macropollutants.
- In **Case Study 4 (Nafplio, Greece)** the pilot plant has been already fully deployed at the quarters of Alberta S.A. It has the capacity to treat 10m³/day of water by product originating from various juice production streams. The pilot comprises all the processes needed to recover valued-added





compounds, polyphenols, with an adsorption/extraction unit, and wastewater treatment: coagulation and advanced oxidation process to remove organic load. The pilot unit is currently operational, though we are still facing teething issues mainly piping leaking and automation issues. We are currently working to integrate more features of the pilot unit under the automation platform. Although pilot plant is in operation, in this report laboratory experiments results are presented.

- In **Case Study 5 (Lleida, Spain)** a 2 m³/h NF pilot plant is in operation to treat wastewater from the brewery. In Case Study 5 (Lleida, Spain), nanofiltration and reverse osmosis pilot plant, with a treatment capacity of 2 m³/h, has been tested for 7 months (between January and September 2022). The obtained NF and RO treated wastewater met, without exception, all the legal requirements for water reuse. The tested technology showed to be robust, tolerating well the oscillations of the water and presenting a stable process in terms of membrane fouling. The pilot test allowed to define the optimal operation settings regarding the NF technology.

Regarding ELSAR®, a pre-commercial industrial-size plant with capacity of treating 20 m³/h of brewery wastewater or an equivalent of 2000 kg COD/day will be built in 2023. The expected biogas production will be 31 Nm³/h. Due to the delays in the pre-commercial ELSAR®, a pilot ELSAR® has been installed. It will treat real brewery wastewater, aiming the validation of processes and structures. The pilot plant contains all the needed elements for simulating in a pilot-scale the same process than in the big-scale, although some processes (like biogas treatment) are non-existent. It is expected to be run beginning 2023 and has a capacity of ca. 5 m³/h.

After installation during all 2022, the AnMBR pilot plant will be commissioned (by means of using anaerobic inoculum) in December 2022, with a capacity of treating ca. 2 m³/h or around 50 m³/d, and a biogas production of ca. 3,5 m³/h.

After installation in spring 2022, the safety inspections in summer 2022, and the commissioning in autumn 2022, the solid oxide fuel cell pilot plant will be commissioned in December 2022, with a capacity of producing 1,3 kW_{electric} and a approx. consumption of 10 m³ of biogas/ day. It will be fed with pre-treated biogas.

Thermosolar-based device has been tested in the batch tests, after 7 hours in a sunny day with normal sunlight irradiation (700-900 W/m²), the tested technology increased between 0,5 and 10-fold the dry matter of the tested samples, depending on the type of sludge (dewatered, thickened or composted). Temperature could not be increased in the HydroThermal Carbonization ranges (>180°C), which forces further research for optimize solar heat profit. Through the tested thermal treatment, Salmonella sp. was easily inactivated, but *Escherichia Coli* and especially *Clostridium perfringens* were not always inactivated even after 30 minutes of treatment. Again, a better heat distribution may help to obtain better results.

- In **Case Study 6 (Karmiel and Shafdan, Israel)** there are two pilot plants in operation. In Karmiel, currently, the advanced anaerobic technology pilot





receives 120 m³/d of wastewater with a COD, TS and TVS loads of 238 kg/day, 97 kg/d and 88 kg/day, respectively. The biogas production rate is 0.3 Nm³/h with a methane content of 70% on average. 98.4–99.6% of the municipal wastewater is mixed with 0.4 – 1.6% olive mill wastewater and treated anaerobically by the advanced anaerobic pilot plant to produce biogas. On the other hand, tests with Karmiel pilot plant will be conducted after integrating the polyphenol extraction unit (adsorption column) from Greener than Greener (CS4), which arrived end of November 2022. It is expected to complete its installation and start-up in January 2022.

To improve the biogas production and the effluent water quality, an immobilized biofilm **advanced anaerobic technology** is combined with membrane filtration and activated carbon at the pilot-scale in Shafdan. The pilot at the Shafdan has been installed, and its operation was started in August 2022. This demonstration system represents a very large WWTP, in order to provide insight into the capability of large WWTPs to combine agro-industrial wastewater. The demonstration plant at the Shafdan receives 12-24 m³/day of municipal wastewater with a COD load of 0.5 m³/d. That volume (12-24 m³/d) will be mixed with 0.2-2 m³/d of oily mill wastewater and will be further treated by AAT and AnMBR systems to produce biogas. Although pilot plant is in operation, and several tests have been conducted with the AAT system and membrane, some problems about sensors, electrical panel and control system took place and for this reason, the complete start-up operation is not already completed.

- In **Case Study 7 (Tain, United Kingdom)** there are two different pilot plants. There is in operation a 1 m³/h pilot plant to recover nutrients from distillery effluent (nitrogen, 800 mg/L and phosphorus 250 mg/L). The pilot plant has first precipitation process for the formation of struvite in a 5 m tall reactor followed by a clarifier and under controlled conditions. As the ammonia is in excess, this step will be focused on maximising the removal of the phosphorus with a target of 80%. The effluent will be further treated in a 5 m tall stripping unit for the removal and recovery of the remaining ammonia present with an overall ammonia recovery target of 90%. In this case, the ammonia will be recovered in the form of an ammonium sulphate solution by scrubbing with sulfuric acid. Both units are designed to treat a flow of 1 m³/h.

For water reuse, a reverse osmosis pilot unit will be used, although currently is installed, commissioned but not in operation. The system is designed to treat flows of up to 1 m³/day and is semi-automated. The unit comprises a feed tank fitted with a heating system to control the temperature of the feed water. This will be of particular interest for the evaluation of residual heat utilisation, to understand the impact of temperature on the treatment and operational performance of the reverse osmosis membranes.

- In **Case Study 8 (Roussillon, France)**, a 500 Nm³/h absorption pilot plant is designed but not built and it is expected to be implemented in April 2023. Initial laboratory tests were conducted, using synthetic gases, to assess the influence of several parameters on sulphur dioxide absorption. Absorption efficiencies > 95% were obtained, considering that pH 6-9.5 and low





temperature promote sulphur dioxide absorption. Furthermore, initial concentration in adsorption solution and sulphur dioxide concentration in the inlet gas seemed not to be impact on sulphur dioxide absorption efficiency,

- In **Case Study 9 (Kalundborg, Denmark)** two parallel operated membrane pilot plants are operated to produce fit-for-purpose water for cooling purposes or for steam production. Their point of application is in the secondary effluent of a municipal wastewater treatment plant, which treats municipal wastewater and pre-treated pharmaceutical and biotech wastewater. The composition of the secondary effluent contains a high fraction of non-degradable organic compounds and is quite challenging for the pilot plants. Until now, different configurations were tested such as the combination of a conventional UF with a RO, an ultra-tight UF with a RO and an open NF with a RO.

The treatment via UF and open NF membranes alone cannot reach the cooling water quality. However, first results showed the effective retention of microorganisms such as *Escherichia coli* and *Legionella*. After RO treatment, nearly all parameters reached the quality that is required for cooling water. Only the pH and the calcium concentration were too low. Therefore, a typical post-treatment for RO permeate such as a chemical stabilisation can be used to meet the requirements for cooling water and to prevent corrosion in the water distribution system.

The water quality for steam production cannot be reached with the current setting of the pilot plant alone. A post-treatment for the RO permeate such as an ion exchanger is required to decrease the concentrations of sodium, potassium and silicate as well as the electrical conductivity. However, this treatment stage is usually present at the industries using steam. Thus, the challenge here is the chemical stabilisation for the supply of water to the industries as this slightly increases also the hardness.

In the coming months it is expected that the case studies will continue working with the pilot plants and that the construction and commissioning of those that have not yet been completed will be finished. Experimental results will be presented and discuss in following reports, and they will be the basis for potential studies to scale-up the ULTIMATE solutions.

4. References

[1] Arthurson, 2008. Proper Sanitization of Sewage Sludge: a Critical Issue for a Sustainable Society. APPL. & ENV. MICROBIOLOGY, Sept. 2008, p. 5267–5275.

[2] Asensio et al. 2021 Upgrading fluidized bed bioelectrochemical reactors for treating brewery wastewater by using a fluid-like electrode. Chemical Engineering Journal, Volume 406, 2021, <https://doi.org/10.1016/j.cej.2020.127103>.

[3] Alejandro Ayala-Cortés, Pedro Arcelus-Arrillaga, Marcos Millan, Camilo A. Arancibia-Bulnes, Patricio J. Valadés-Pelayo, Heidi Isabel Villafán-Vidales, Solar integrated hydrothermal processes: A review, Renewable and Sustainable Energy Reviews, Volume 139, 2021, 110575, ISSN 1364-0321, <https://doi.org/10.1016/j.rser.2020.110575>.





- [4] Das, S., Ray, N. M., Wan, J., Khan, A., Tulip Chakraborty, T., & Ray, M. B. (2017). Micropollutants in Wastewater: Fate and Removal Processes. In R. Farooq, & Z. Ahmad (Eds.), *Physico-Chemical Wastewater Treatment and Resource Recovery*. IntechOpen. <https://doi.org/10.5772/65644>
- [5] Deng WY et al. Measurement and simulation of the contact drying of sewage sludge in a Nara-type paddle dryer. *Chemical Engineering Science* 2009;64:5117–24.
- [6] DIN EN 12952-12:2003-12 (2003). *Wasserrohrkessel und Anlagenkomponenten - Teil 12: Anforderungen an die Speisewasser- und Kesselwasserqualität*. DIN.
- [7] Gao, N., Kamran, K., Quan, C., & Williams, P. T. (2020). Thermochemical conversion of sewage sludge: A critical review. In *Progress in Energy and Combustion Science* (Vol. 79). Elsevier Ltd.
- [8] Ischia G., Castello D., Orlandi M., Miotello A., Rosendahl L.A., Fiori L., 2020, Waste to Biofuels through Zero-energy Hydrothermal Solar Plants: Process Design, *Chemical Engineering Transactions*, 80, 7-12 DOI:10.3303/CET2080002.
- [9] Kazak, O., & Tor, A. (2020). In situ preparation of magnetic hydrochar by co-hydrothermal treatment of waste vinasse with red mud and its adsorption property for Pb(II) in aqueous solution.
- [10] J. Larminie, A. Dicks, M.S. McDonald, *Fuel Cell Systems Explained*, Wiley New York, 2003.
- [11] Liew et al. 2022, *Chemosph.*, Vol. 292. <https://doi.org/10.1016/j.chemosphere.2021.133478>.
- [12] Method for treating wastewater in a fluidized bed bioreactor (Ref. EP 2927196 A1).
- [13] Niewersch, C., et al. (2016). Deliverable 1.3 - Report on innovative membrane technologies and schemes for water reuse.
- [14] Robbiani, Z. (2013). Hydrothermal carbonization of biowaste/fecal sludge.
- [15] Royal Decree 1620/2007 (2011). Spanish Regulations for Water Reuse - Royal Decree 1620/2007 of 7 December. A. Spanish Association for Sustainable Water Reuse, U. Universitat Politècnica de Catalunya and C. d. I. C. B. CCB.
- [16] Saadabadi et al., 2019. <https://doi.org/10.1016/j.renene.2018.11.028>.
- [17] N.S. Siefert, S. Litster, Exergy & economic analysis of biogas fueled solid oxide fuel cell systems, *J. Power Sources* 272 (2014) 386e397.
- [18] Towards the practical application of bioelectrochemical anaerobic digestion (BEAD): Insights into electrode materials, reactor configurations, and process designs. <https://doi.org/10.1016/j.watres.2020.116214>.
- [19] VDI 2047 Blatt 2 (2015). VDI 2047 Blatt 2 - Rückkühlwerke – Sicherstellung des hygiene-gerechten Betriebs von Verdunstungskühlanlagen. Düsseldorf. VDI e. V.

